



Variable Refrigerant Flow Systems

AIRSTAGE®

HEAT PUMP & HEAT RECOVERY
VRF CATALOG



TABLE OF CONTENTS

Our Message.....	3
VRF Outdoor & Indoor Unit Intro	6
FEATURES	8
High Energy Efficiency	9
More Comfort.....	12
High Reliability.....	14
Design Flexibility.....	16
Easy Installation	18
Easy Service & Maintenance	20
MODEL LINEUP	
Indoor and Outdoor Model Table	22
OUTDOOR UNITS	
J-IV Heat Pump, 208-230V / 1-Phase	24
J-IVs Heat Pump, 208-230V / 1-Phase.....	28
J-IIIIL Heat Pump, 208-230V / 3-Phase.....	32
V-II Heat Pump Models, 208-230V, 460V	36
VR-II Heat Recovery Models, 208-230V, 460V	40
INDOOR UNITS.....	44
Compact Cassette	46
Large Circular Flow Cassette.....	48
Large 4-way Cassette	50
Slim Compact Duct	52
Medium Static Pressure Duct	54
High Static Pressure Duct (ARUH36, 48, 60)	56
High Static Pressure Duct (ARUH72, 96)	58
Multi-Position Air Handling Unit.....	60
Floor Mount.....	62
Floor/Ceiling	64
Ceiling	66
Compact Wall Mounts.....	68
Wall Mounts	70
VENTILATION	72
DX Kit	74
Outdoor Air Unit	76
HRV / ERV Solutions	78
CONTROL SYSTEMS & TOOLS.....	80
Control System Overview	82
Remotes & Controllers Features Table.....	84
Individual Controls.....	85
Centralized Controllers.....	91
BMS Gateways	97
Wi-Fi Interfaces.....	101
Converters/Adapters	102
Service & Design Tools.....	105
OPTIONAL PARTS OVERVIEW	112
Separation Tubes	114
RB Units.....	115
Auto Louver Grille Kit.....	116
Wind Baffles, Hail Guards, SNow Hoods.....	117
Airzone.....	118
Hi-Rise 360.....	120
APPLICATIONS / RESOURCES	
Facility Applications.....	121
Commercial Financing	126
Warranty and General Info.....	127

AIRSTAGE®

Variable Refrigerant Flow System

For Small and Large Buildings

- Extensive lineup from 3 to 24 tons
- Connectable capacity ratio up to 150%
- 58 different indoor units available in 14 styles
- Up to 63 indoor units per one VRF system
- Three outdoor V-Series units may be combined with Branch Kits to create up to 24-ton systems
- 10-Year Parts and Compressor Warranty See Warranty Statement for details
- Extensive training available for Engineers, Architects, Contractors and Distributors

High Efficiency & Reliability

Outdoor Units

J-Series



3, and 4 tons
Single-phase



3, 4 and 5 tons
Single-phase



6, 8 and 10 tons
Three-phase

V-Series



6 and 8 tons
Three-phase



10 Ton
Three-phase

A World Leader in Heating and Cooling Solutions

Support Team

Fujitsu features an expert team of Regional Sales Managers and Sales Engineers located around North America to provide customer support. Additionally, blended Rep Agencies support Plan and Spec Consulting Engineers, as well as wholesale distribution, to provide product knowledge and support. We pride ourselves in having one of the most educated and qualified teams in the HVAC industry.



Technical Support

The Fujitsu support experience is top notch! We have highly trained and field-experienced technicians on staff as well as strategically placed, Regional Support Specialists (RSS) to provide local support. The service team works closely with Quality, Product, and R&D team members in the US and overseas for new product innovation and improvement.

Service department enhancements include:

- Enhanced VIP call routing / lower wait times.
- Mobile Technician app: troubleshoot error codes, thermistors and pressure sensors
- 24-hour response on Servicehvac@fujitsugeneral.com
- Zendesk guide for technical information
- Zendesk chat

Research & Development

The Headquarters-R&D Center (Japan) is equipped with a wide range of testing equipment envisioning a variety of operating conditions. This includes a testing tower with a 197ft. (60m) height difference for testing systems for tall buildings. We provide high quality & reliable products that meet the customers' needs from all over the world through this advanced R&D Center and 6 factories based in China and Thailand.



R&D Center & Technology Research Building



R&D Center in Fujitsu General America (U.S.A.)

Overseas Manufacturing Companies



Fujitsu General (Shanghai) Co., Ltd. (China)



Fujitsu General Air Conditioning R&D (Thailand) Co., Ltd. (Thailand)



North America R&D Center (U.S.A.)



F.G.L.S. Electric Co., Ltd. (China)



Fujitsu General (Thailand) Co., Ltd. (Thailand) FACTORY-2



JAPAN Head Office, R&D Center and 60 m Height Difference Testing Tower (Japan)



Fujitsu General Central Air-conditioner (Wuxi) Co., Ltd. (China)



Fujitsu General (Thailand) Co., Ltd. (Thailand)



Technology Research Building in Japan Head Office



FGA (Thailand) Co., Ltd. (Thailand)



TCFG Compressor (Thailand) Co., Ltd. (Thailand)

OUR HISTORY

Overseas Air Conditioning Business since 1971
VRF Business since 2001

FUJITSU GENERAL's VRF AIRSTAGE™ Series has been developed based on our long-term air-conditioning technology know-how and was first launched 20 years ago. We have offered a series of products from large homes to large-scale buildings to meet the various market needs.



AIRSTAGE V-II

460V 3-Phase
6 to 24 tons / Heat Pump
100% Inverter driven



AIRSTAGE VR-II

208/230V 3-Phase
6 to 24 tons / Heat Recovery
100% Inverter driven



AIRSTAGE V-II

208/230V 3-Phase
6 to 24 tons / Heat Pump
100% Inverter driven



AIRSTAGE VR-II

VR-II series
High efficiency and compact design model
6 to 24 tons / Heat Recovery



AIRSTAGE V-II

V-II series
High efficiency and compact design model
Extensive lineup from 6 to 24 tons
in 2 ton increments / Heat pump



S series
8 tons / Heat recovery
& Heat pump



V series
6 to 30 tons / Heat pump

8 tons / Heat recovery
6, 8 tons / Heat pump
& Cooling

AIRSTAGE™ History



History of Environmental Measures

Certification Acquisition of ISO14001

- 1998 : Fujitsu General (Shanghai) Co.,Ltd.
- 1999 : Fujitsu General (Thailand) co.,Ltd.
- 2002 : FGA(Thailand) Co.,Ltd.
- 2006 : Fujitsu General Central Air-conditioner (Wuxi) co.,Ltd.

Green Initiatives
Fujitsu introduces inverter technology and the use of environmentally friendly R410A refrigerant.



RoHS Compliant
Restriction of Hazardous Substances is an EU directive intended to protect the environment by forcing manufacturers to use environmentally friendly materials in all consumer electronics.





AIRSTAGE™ VR-II

460V 3-Phase

6 to 24 tons / Heat Recovery
100% Inverter driven



AIRSTAGE™ J-III L

208/230V 3-Phase

J-III Series
High efficiency, medium capacity model
6, 8, 10 tons / Heat pump



AIRSTAGE™ J-IV

208/230V 1-Phase

J-IV series
3, 4, 5 tons / Heat Pump
Expanded heating operation range for cold climates, connect up to 15 indoor units



AIRSTAGE™ J-IIS

208/230V 1-Phase

J-IIS Series
High efficiency, small capacity model
3, 4 tons / Heat pump



AIRSTAGE™ J-II

208/230V 1-Phase

J-II Series
High efficiency, small capacity model
3, 4 and 5 tons / Heat pump



AIRSTAGE™ J-IVS

208/230V 1-Phase

J-IVS series
3, 4 tons / Heat Pump
Expanded heating operation range for cold climates, connect up to 12 indoor units

North America

2014

2015

2017

2019

2021

Green Advancement
Use of 100% inverter driven
DC compressors.

INVERTER

Light Commercial & Commercial, Residential VRF

AIRSTAGE™ VRF systems can be designed to create an air conditioning solution to suit most building requirements.

AIRSTAGE™ VRF systems can be designed to effectively provide an air conditioning solution from a large domestic residence to a large scale commercial building.

- p. 8 Features
- p. 22 VRF Outdoor Units Lineup

VRF Outdoor Units



AIRSTAGE™ J Series Heat Pump for Small Capacity Type

- p. 24 AIRSTAGE™ J-IV
- p. 28 AIRSTAGE™ J-IVS
- p. 32 AIRSTAGE™ J-IIIIL



AIRSTAGE™ V Series Heat Pump Modular Type

- p. 36 AIRSTAGE™ V-II

Heat Recovery Modular Type

- p. 40 AIRSTAGE™ VR-II

VRF INDOOR UNITS

- p. 44 VRF Indoor Units Lineup
- p. 46 VRF Indoor Units



The AIRSTAGE logo is prominently displayed in the upper left quadrant of the page. It consists of the word "AIRSTAGE" in a bold, blue, sans-serif font, with a stylized blue swoosh above the letter "A". The background of the entire page is a low-angle photograph of a modern glass skyscraper with a blue sky.

V R F

Light Commercial &
Commercial,
Residential

Features

High Efficiency

High system efficiency is achieved by using DC twin rotary compressor, scroll compressor, inverter technology, and large efficient heat exchanger.



DC twin rotary compressor

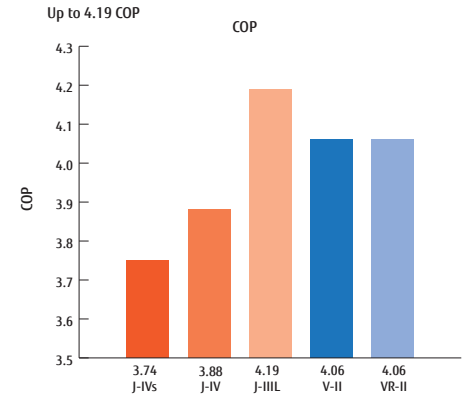
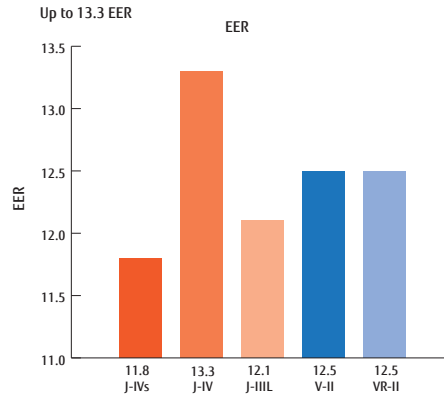

ALL DC High efficiency design with top class SEER, IEER and COP

All VRF Series including J-IIIIL Series utilize DC technology to achieve high efficiency operation. This technology improves both the durability and reliability of the systems.

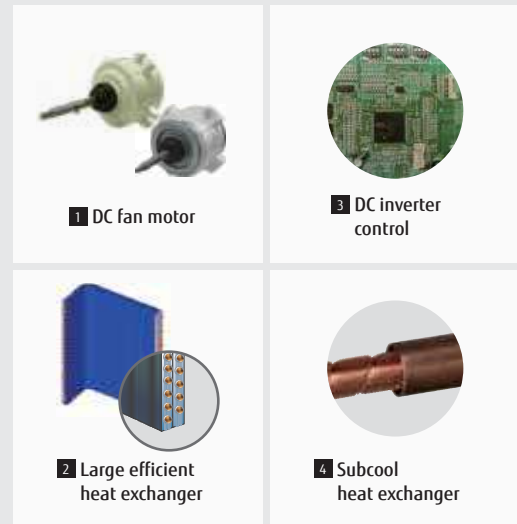

Operation Performance is Efficiently Controlled



Room temperature set point limitation

The minimum and maximum temperature set point ranges can be limited, which can provide further energy saving while maintaining the comfort of the occupants.

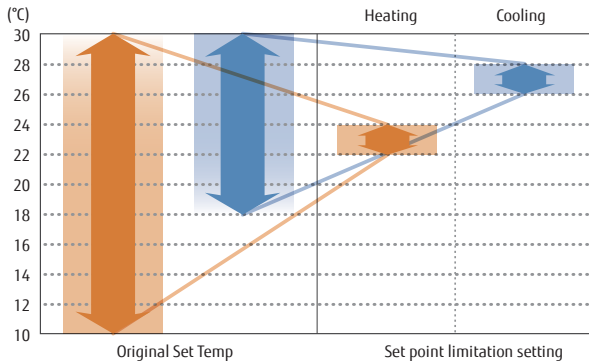

Auto-off timer

The wired remote controller is equipped with an OFF timer function that automatically stops operation when a fixed time has elapsed from the start of operation. This can increase the energy efficiency. Furthermore the wired RNRUZ* remote controller can set up the interval of time in case operation stops.

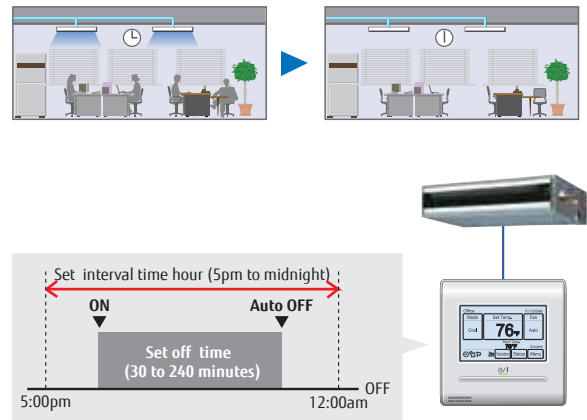

Energy saving management

The system controller can be used to set a variety of different energy saving operations, depending on the season, weather, and occupant schedules.

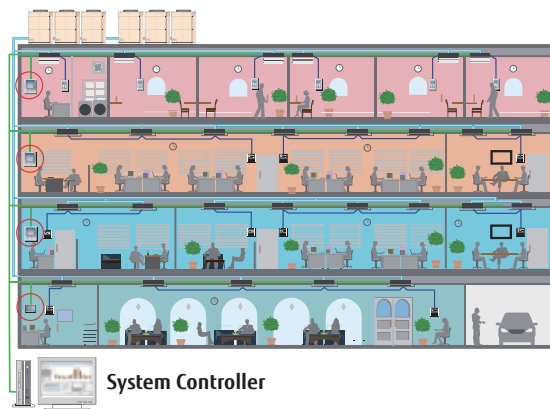

Capacity save operation

Operation capacity can be adjusted based on capability and lowered power usage. The outdoor units can be set for capacity limiting through a BACnet gateway.

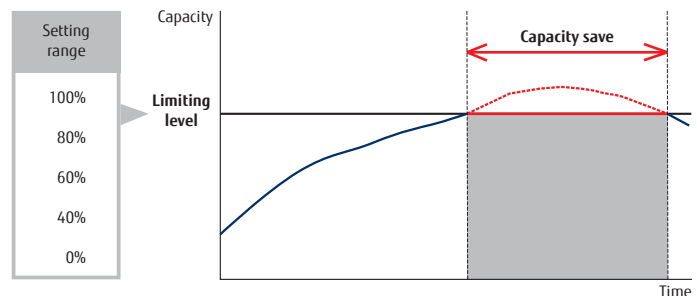



Intelligent refrigerant control

Fujitsu intelligent refrigerant control optimizes the comfort in each individual zone while providing reliable and energy-efficient system operation.

The intelligent refrigerant control minimizes starting and stopping of the compressors while keeping the target zone temperatures. The control also maximizes energy efficiency by running the compressors longer times but at an optimized speed.

Outdoor unit with improved refrigerant control

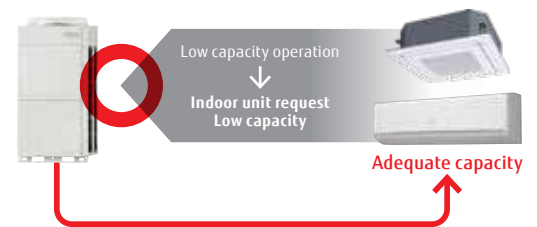

Outdoor unit supplies adequate capacity based on demand from indoor unit

* The improvement by the control and the actual sine wave varies by the combination of the indoor unit and system operating condition.

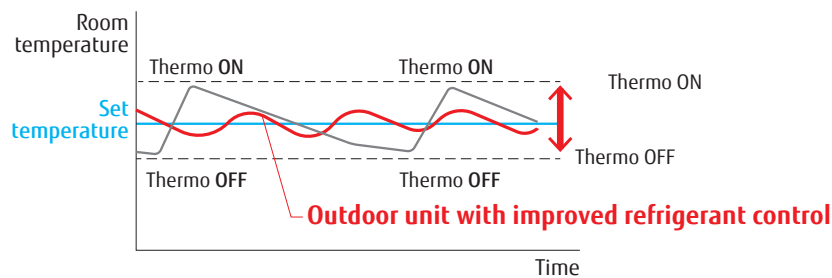

More Comfort



Auto changeover function

In Auto setting mode in a Heat Recovery system, the cooling/heating mode is automatically switched in each room according to the set temperature and actual room temperature.

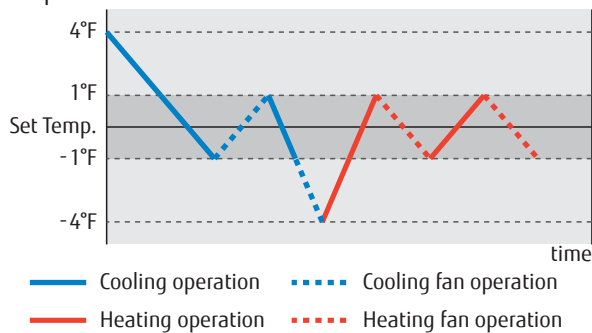

Auto changeover setting allows for each indoor unit to easily switch between cooling and heating regardless of the operation mode of other indoor units. This ensures optimized comfort all year round.

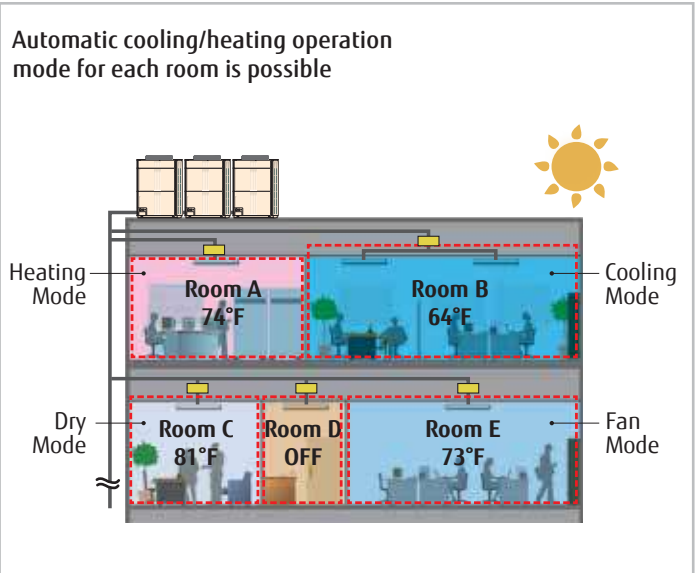

Precision refrigerant flow control

Precise and smooth refrigerant flow control is achieved by using DC Inverter control in conjunction with individual indoor unit electronic expansion valve control. This allows high precision comfortable temperature control of $\pm 1^\circ\text{F}$.

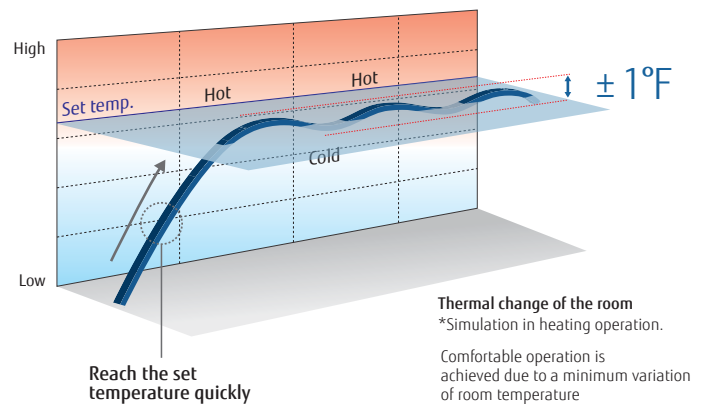

Quiet operation



Quiet operation

Two low noise modes can be selected automatically by quiet priority setting and capacity priority setting depending on the indoor environment and outside temperature load. This feature can be controlled via outdoor unit external input and/or system controller.

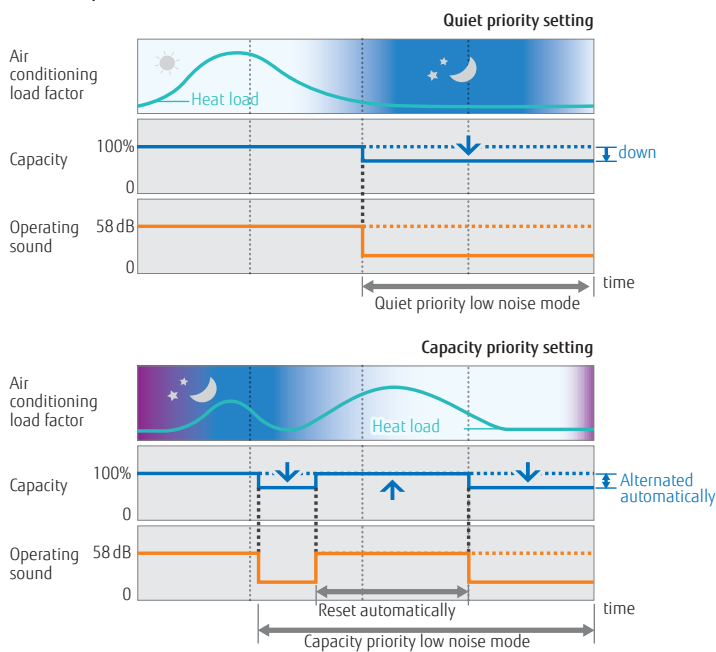

Non-stop oil recovery operation

The system continues to operate and maintain a comfortable room condition even during the brief oil recovery mode operation.

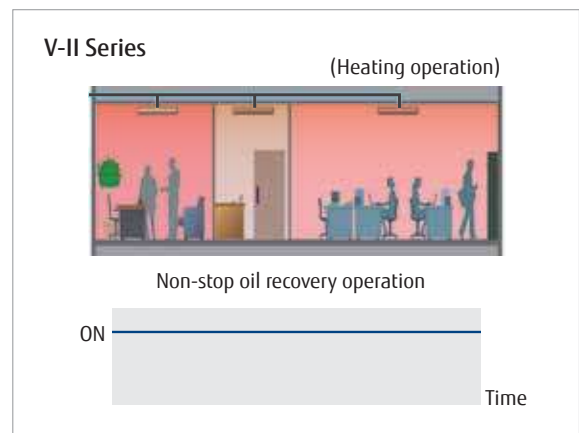

Low sound level design

All the indoor units in the Airstage system have a low sound level design. In low capacity operation the sound level can be as slow as 21dB(A).



High Reliability

Outdoor unit rotational operation

The compressor starting order is rotated so that the running time is shared.

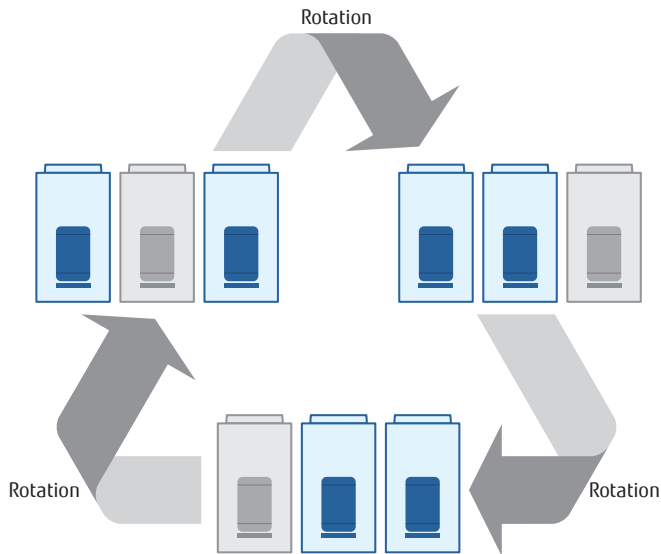

Note: Rotational operation is alternated by the start / stop timing of the compressor.

Backup operation

If one compressor fails, backup operation will be performed by the remaining compressors*.

*Note: Backup operation capability depends on system conditions.

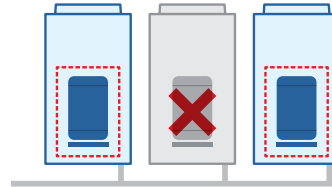

Advanced refrigerant control

Innovative compressor control logic is used in order to balance the refrigerant flow rate of each outdoor unit by controlling the inverter speed.

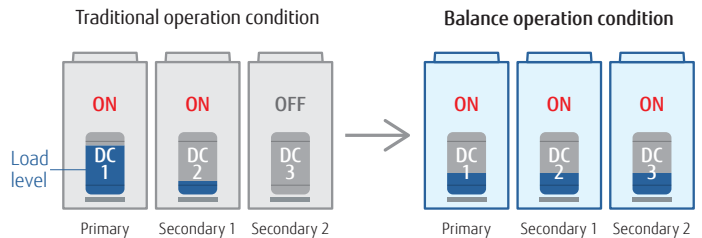

Liquid protection technology

By utilizing a large sized accumulator, not completely vaporized refrigerant stays inside the accumulator to ensure no liquid refrigerant is being fed into the compressor.

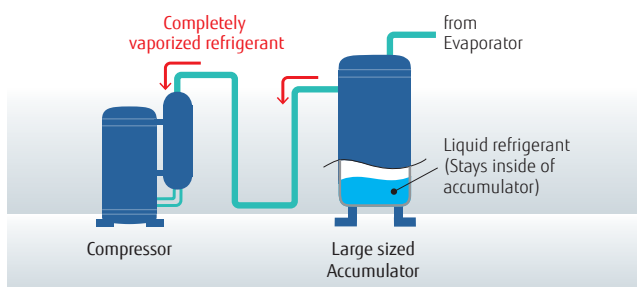

Blue fin heat exchanger

Blue fin coating of the outdoor unit heat exchanger ensures corrosion protection for harsh environments.

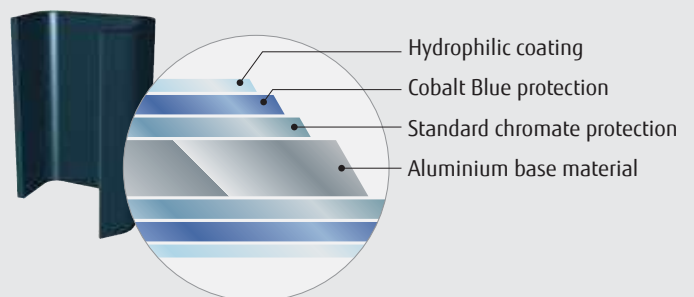

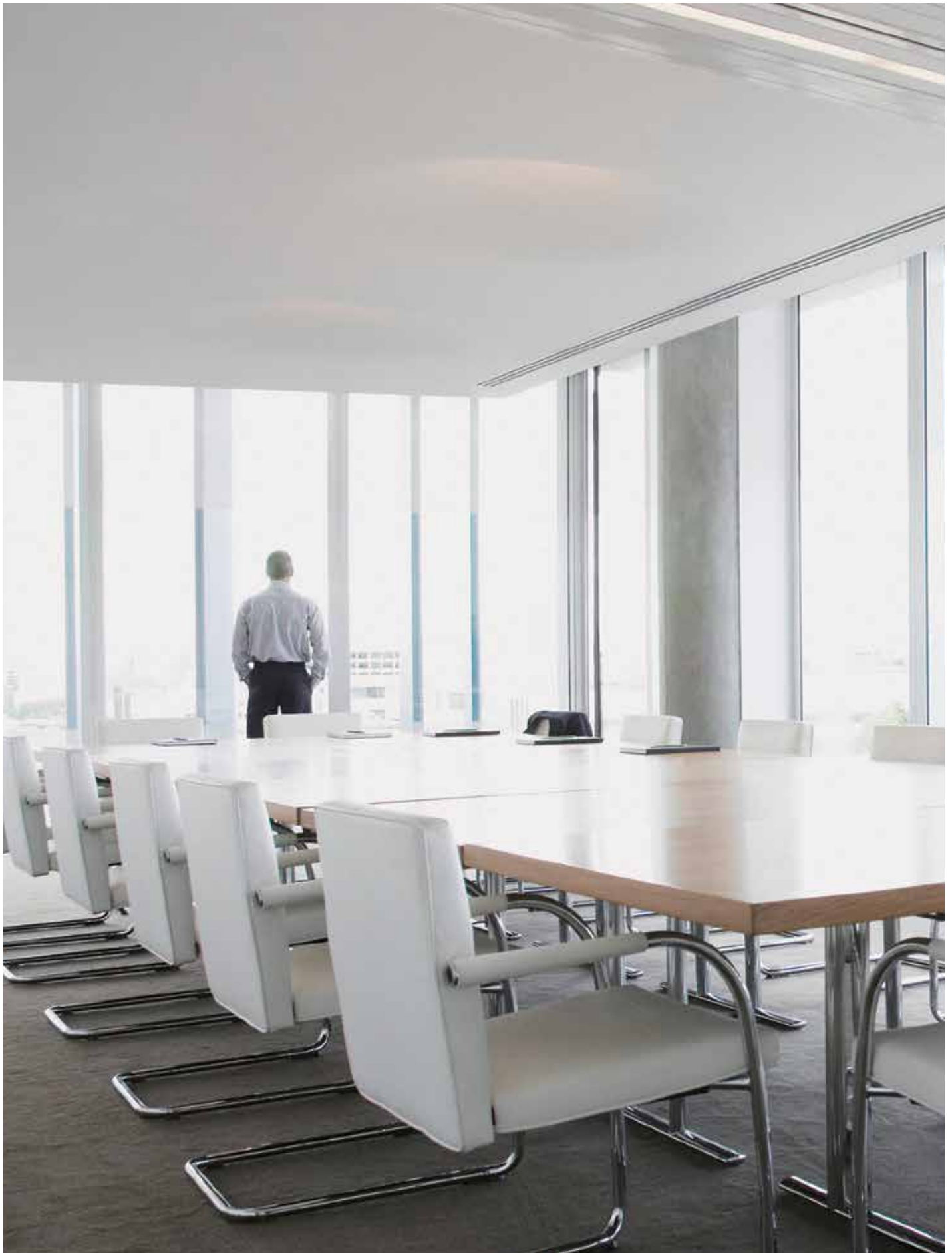

Design Flexibility



Top class compact design

Compact outdoor unit and optimal airflow structure design.



AIRSTAGE™ J-Series Compact Outdoor Unit

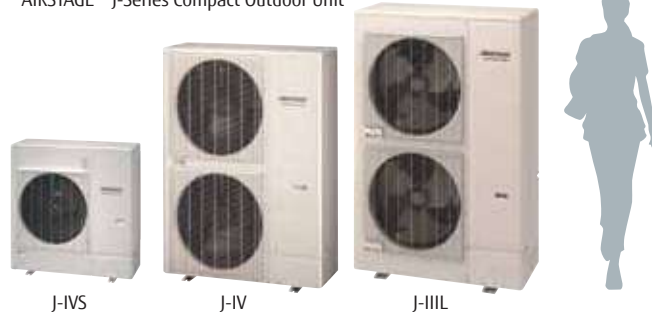

Long piping design

Generous piping limitations to accommodate system to be installed in long and tall buildings.



Allows for application in a wide variety of buildings.

AIRSTAGE™ J-IVL Series

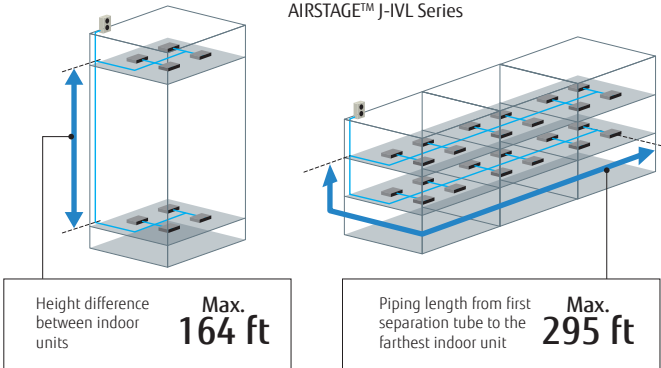

AIRSTAGE™ V-II Series & VR-II Series

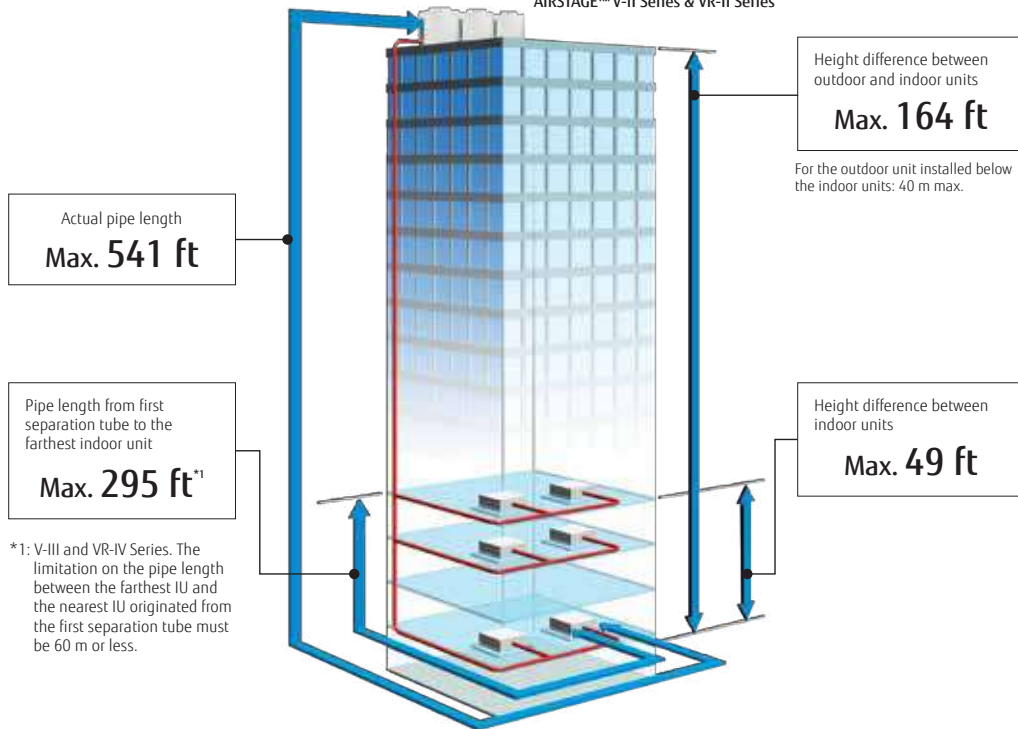

^{*1}: V-III and VR-IV Series. The limitation on the pipe length between the farthest IU and the nearest IU originated from the first separation tube must be 60 m or less.

High capacity connection

Series	Connectable indoor unit total capacity range	Connectable indoor unit quantity
J-IVs	50% to 130%	up to 12
J-IV	50% to 150%	up to 15
J-IIIIL	50% to 150%	up to 30
V-II	50% to 150%	up to 63
VR-II	50% to 150%	up to 45



Designed for low refrigerant charge

Optimal design of indoor unit and outdoor unit reduces the refrigerant volume in a system to enable installation in small spaces while adhering to local codes.



Optional parts

- Integrated outside air intake capabilities with optional air intake kits for several of the indoor units.
- Comfortable room temperature with advanced controls and remote sensor options.
- DX-Kit that enables seamless integration of non-VRF air handling units into the VRF system.

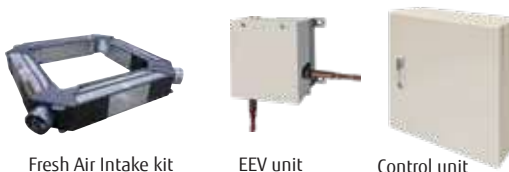

Fresh Air Intake kit

EEV unit

Control unit



Low ambient operation

Improved refrigeration technology allows system operation in colder climates.



Extended operating range

Extended operation range enables heating and cooling in colder climates.

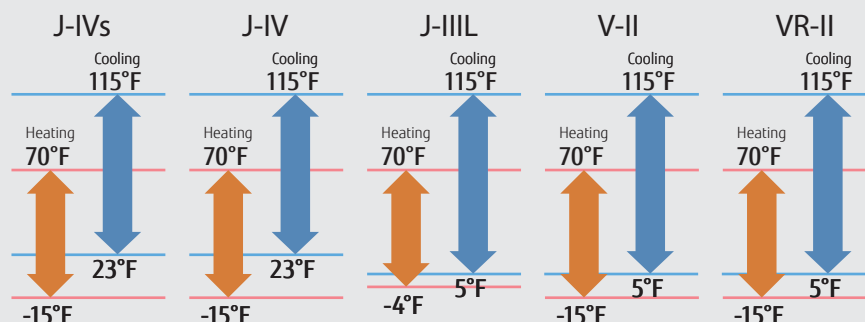

Easy Installation

Easy to transport

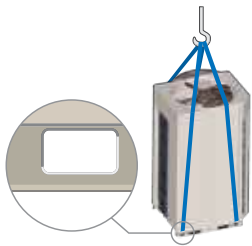

Easy to lift with a crane

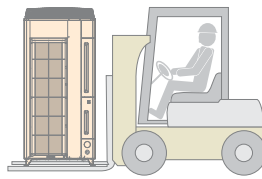

Easy to move with a forklift



Can fit in a standard elevator

Easy access

The L-Shape front panel, that easily can be removed, increases the space for installation and service.

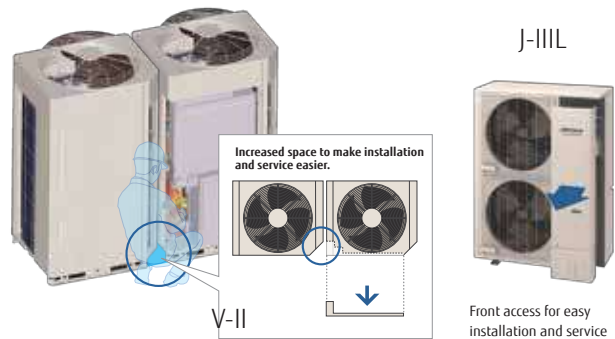

Flexible piping connection

Piping and wiring are available through the front, left, right and bottom.





Simple wiring work

Installation of the wiring systems is made easier as the communication wiring can be installed continuously between the indoor, outdoor and RB units.

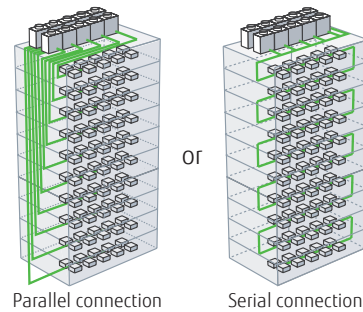

Up to maximum length
11,811 ft

Easy evacuation - using vacuum mode function

The vacuum mode function enables all expansion valves of indoor units to be fully opened, making the evacuation of the refrigerant circuit easy after installation.

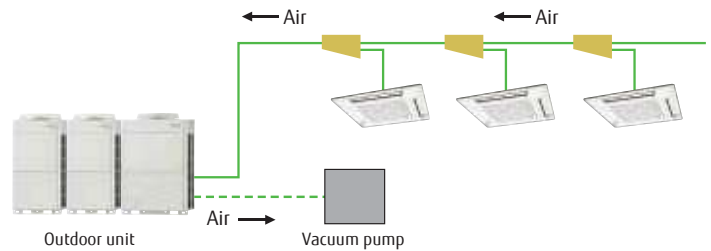

Automatic address setting

Address setting of the indoor unit, RB unit and signal amplifier through the automatic function setting on the outdoor unit PCB.

Automatic address setting is performed at outdoor unit

Addresses are automatically distributed from outdoor unit.

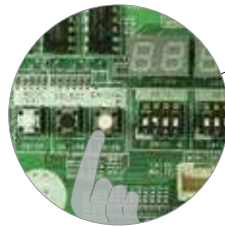

Press the push button of outdoor unit.

Manual address setting from indoor unit and remote controller is also possible.

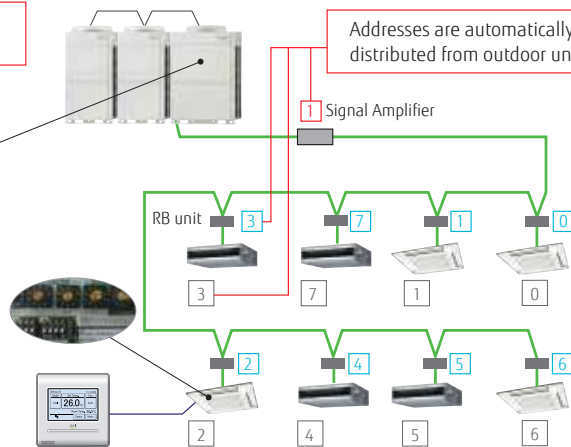

Easy commissioning by Service Tool

User friendly service tools that can show system conditions such as refrigerant temperatures and pressures, electronic expansion valve position, etc., makes it easy to verify proper system operation.



Easy Service & Maintenance

Designed for Easy Maintenance

7 segment LED displays makes it easy to verify operation details such as function setting status, refrigerant temperature, pressure, compressor operation time, etc.

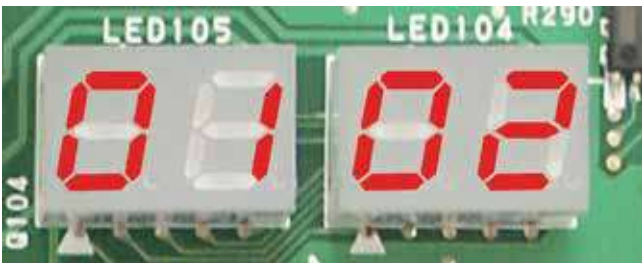

Easy to read 7-segment LED

Operating status for Outdoor Unit can easily be checked on the display:

- Operation mode status
- Discharge temperature/Pressure status
- Compressor operation indication
- Address/type/number of outdoor unit

Removable PCB panel
Enables easy maintenance access





Operating status can be checked easily via the indoor unit wired controller

An operation code is displayed on a liquid crystal screen.

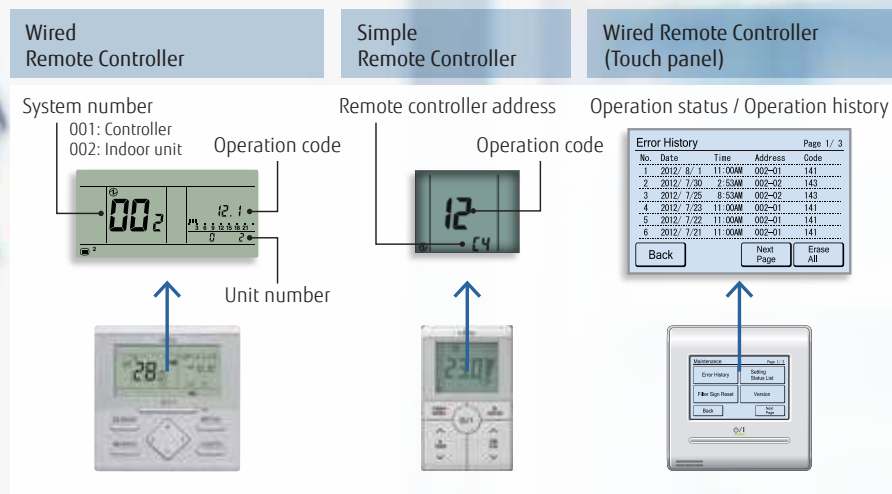

Operation diagnosis by Service Tool

Connection to Service Tool

- Detailed operation status and recent operation history can be checked and analyzed by using the Service Tool.
- Operation status of the last 5 minutes stored in memory.

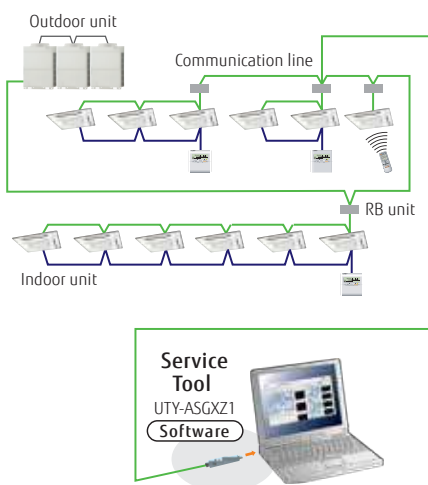



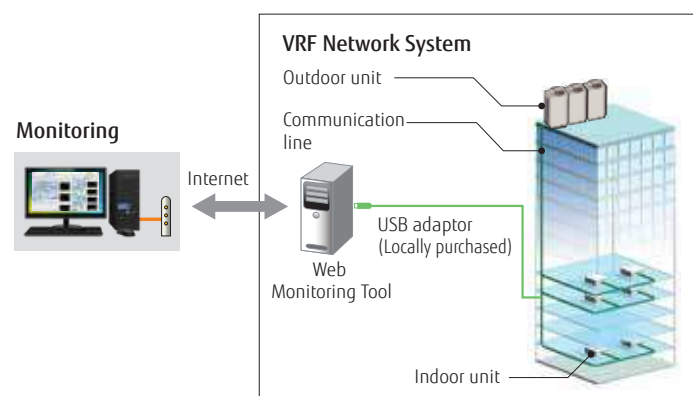

Remote monitoring

































The Web Monitoring system allows you to view system operation anytime over the internet, ensuring issue free operation.







































OUTDOOR UNITS LINEUP

3-PHASE / 208-230V			1-PHASE / 208-230V	
J-IIIIL			JIV-S	
J-SERIES  6-ton AOU72RLAVL	 8-ton AOU96RLAVL	 10-ton AOU120RLAVL	 3-ton AOU36RLAVS4	 4-ton AOU48RLAVS4
3-PHASE POWER SOURCE: LBV = 208-230V, LCV = 460V				
V-II HEAT PUMP  72,000 BTUh (6-tons) 21.1 kW (8HP) AOUA72RLBV / RLBV1 AOUA72RLCV	 96,000 BTUh (8-tons) 28.1 kW (10HP) AOUA96RLBV / RLBV1 AOUA96RLCV	 120,000 BTUh (10-tons) 35.2 kW (12HP) AOUA120RLBV1 AOUA120RLCV	 144,000 BTUh (12-tons) 42.2 kW (16HP) AOUA144RLBVG1 / RLBVG1 AOUA144RLCVG	 168,000 BTUh (14-tons) 49.2 kW (18HP) AOUA168RLBVG1 / RLBVG1 AOUA168RLCVG
VR-II HEAT RECOVERY  72,000 BTUh (6-tons) 21.1 kW (8HP) AOUA72TLBV AOUA72TLCV	 96,000 BTUh (8-tons) 28.1 kW (10HP) AOUA96TLBV AOUA96TLCV	 120,000 BTUh (10-tons) 35.2 kW (12HP) AOUA120TLBV AOUA120TLCV	 144,000 BTUh (12-tons) 42.2 kW (16HP) AOUA144TLBVG AOUA144TLCVG	 168,000 BTUh (14-tons) 49.2 kW (18HP) AOUA168TLBVG AOUA168TLCVG

INDOOR UNITS LINEUP

Capacity range (BTUh)	4,000	7,000	9,000	12,000	14,000	18,000
Compact Cassette¹	 AUUA4TLAV2	 AUUA7RLAV / TLAV2	 AUUA9RLAV / TLAV2	 AUUA12RLAV / TLAV2	 AUUA14RLAV / TLAV2	 AUUA18TLAV2
Large Circular Flow Cassette²						 AUUB18TLAV1 / TLAV2
Large 4-Way Cassette³						 AUUB18RLAV / TLAV
Mini-Duct	 ARUL4TLAV1 / TLAV2					
Slim Compact Duct		 ARUL7RLAV / TLAV2	 ARUL9RLAV / TLAV / TLAV2	 ARUL12RLAV / TLAV2	 ARUL14RLAV / TLAV / TLAV2	 ARUL18TLAV2
Medium Static Pressure Duct						
High Static Pressure Duct						
Multi-Position Air Handling Unit				 ARUX12TLAV2		 ARUX18TLAV2
Floor Mount	 AGUA4TLAV2	 AGUA7TLAV2	 AGUA9TLAV2	 AGUA12TLAV2	 AGUA14TLAV2	
Floor/Ceiling				 ABUA12TLAV / TLAV2	 ABUA14RLAV / TLAV / TLAV2	 ABUA18RLAV / TLAV / TLAV2
Ceiling						
Compact Wall Mount	 ASUA4TLAV1 / TLAV2	 ASUA7TLAV1 / TLAV2	 ASUA9RLAV / TLAV1 / TLAV2	 ASUA12RLAV / TLVA2	 ASUA14RLAV / TLAV / TLAV1 / TLAV2	
Wall Mounted						 ASUB18TLAV1
Outdoor Air Unit						
Airflow Rate CFM (m3/h)		636 (1,080)	989 (1,680)	1,236 (2,100)		
Outdoor Air Unit		 AAUA48TLAV ⁴	 AAUA72TLAV ⁵	 AAUA96TLAV ⁵		

1-PHASE / 208-230V		J-IV						
J-SERIES	3-ton	4-ton	5-ton					
	AOU36RLAVM4	AOU48RLAVM4	AOU60RLAVM4					
V-II HEAT PUMP	192,000 BTUh (16-tons) 56.2 kW (20HP)  AOUA192RLBVG / RLBVG1 AOUA192RLCVG	216,000 BTUh (18-tons) 63.3 kW (24HP)  AOUA216RLBVG / RLBVG1 AOUA216RLCVG	240,000 BTUh (20-tons) 70.3 kW (26HP)  AOUA240RLBVG / RLBVG1 AOUA240RLCVG	264,000 BTUh (22-tons) 77.3 kW (28HP)  AOUA264RLBVG / RLBVG1 AOUA264RLCVG	288,000 BTUh (24-tons) 84.3 kW (28HP)  AOUA288RLBVG / RLBVG1 AOUA288RLCVG			
	VR-II HEAT RECOVERY	192,000 BTUh (16-tons) 56.2 kW (20HP)  AOUA192TLBVG AOUA192TLCVG	216,000 BTUh (18-tons) 63.3 kW (24HP)  AOUA216TLBVG AOUA216TLCVG	240,000 BTUh (20-tons) 70.3 kW (26HP)  AOUA240TLBVG AOUA240TLCVG	264,000 BTUh (22-tons) 77.3 kW (28HP)  AOUA264TLBVG AOUA264TLCVG	288,000 BTUh (24-tons) 84.3 kW (28HP)  AOUA288TLBVG AOUA288TLCVG		
		24,000	30,000	36,000	48,000	60,000	72,000	96,000
		 AUUA24RLAV / TLAV2						
		 AUUB24TLAV1 / TLAV2	 AUUB30TLAV1 / TLAV2	 AUUB36TLAV2	 AUUB48TLAV1 / TLAV2			
		 AUUB24RLAV	 AUUB30RLAV					
		 ARUM24TLAV2	 ARUM30RLAV / TLAV / TLAV2	 ARUM36RLAV / TLAV / TLAV2				
		 ARUH24TLAV2	 ARUX30TLAV2	 ARUH36TLAV	 ARUH48TLAV	 ARUH60TLAV	 ARUH72TLAV2	 ARUH96TLAV2
				 ARUX36TLAV2	 ARUX48TLAV2 ⁴	 ARUX60TLAV2 ⁴		
		 ABUA24TLAV / TLAV2	 ABUA30TLAV / TLAV2	 ABUA36RLAV / TLAV / TLAV2				
		 ASUB24TLAV1	 ASUA30TLAV2	 ASUA36TLAV1 / TLAV2				

1. Compact Cassette Grille UTG-CCGV sold separately. Must order one with each Compact Cassette.
2. Cassette Grille UTG-LCGVCW (White) or UTG-LCGVCB (Black) sold separately. Must order one with each Cassette.
3. Cassette Grille UTG-LCGV sold separately. Must order one with each Cassette.
4. J-Series compatibility is dependent on outdoor unit capacity.
5. Not compatible with J-Series.

NEW

Heat Pump

Single phase 208/230V

3, 4, 5 Ton

AIRSTAGE™ J-IV

System configuration example

- This system is used for small and medium-sized buildings.
- Connection of up to 15 indoor units to one outdoor unit.

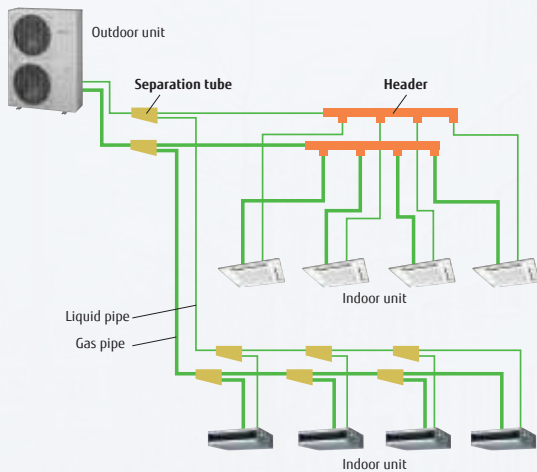

Expanded Heating Operation Range

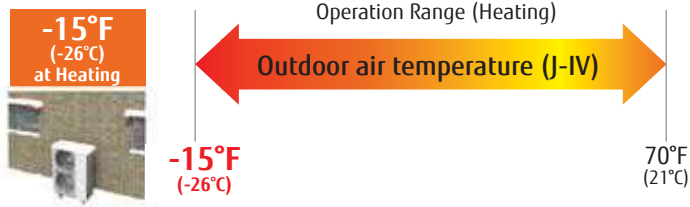

Breaker size optimized

40A ⇒ **30A**

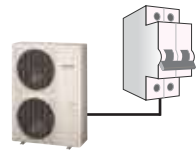

		J-IV	
	3 Ton	30A	
	4 Ton	30A	

Intelligent refrigerant control

The intelligent refrigerant control provides improved comfort for people and energy-efficient operation.

External static pressure

Increased installation flexibility with available external static pressure up to 0.12 in WG.



Advanced high efficiency technology

- Large and efficient propeller fan**
Efficient high performance fan with low sound level.
- DC fan motor**
Low sound level, high efficiency multi-stage DC fan motor.
- Large efficient heat exchanger**
High efficiency 3-row heat exchanger.
- High efficiency compressor motor**
- Optimized refrigerant flow design**
- Efficient DC Inverter control**
Improved efficiency with active filter module
- Subcooling heat exchanger**
Efficient cooling performance with dual tube heat exchanger
- DC twin rotary compressor**
DC twin rotary compressor for high efficiency in all load situations

Pressure-Enthalpy Diagram: Shows a refrigerant cycle with 'effect' and 'Cooling performance improved' indicated.

Compressor Efficiency Diagram: Shows 'High compressor efficiency' vs 'Compressor capacity High' for the 'DC Twin Rotary compressor'.

Long piping length

Fujitsu advanced refrigerant control technology allows a total refrigerant piping length of 590 ft.

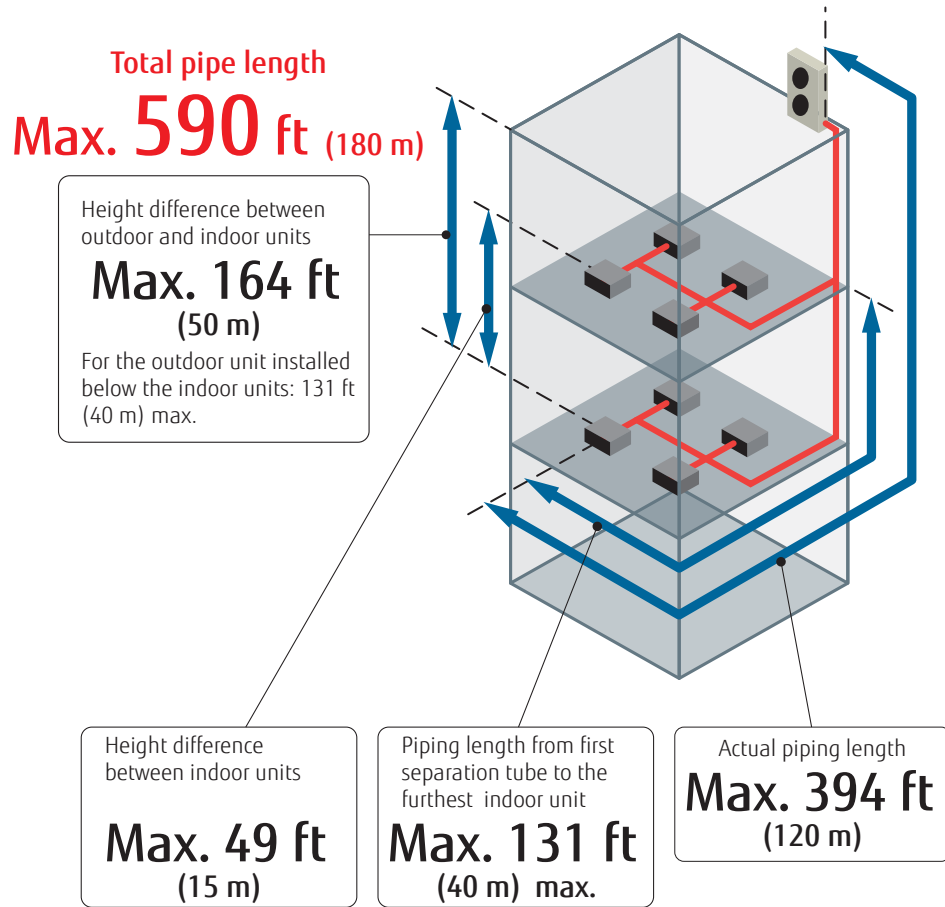

Continous heating and cooling during oil return operation

Room comfort is kept with continuous heating and cooling even during the brief oil return operation.

J-IV Series



Non-stop oil recovery operation



Up to 15 indoor units can be connected in one system

Model	J-IV		
	Nominal System Capacity (tons)	4	5
Number of connectable indoor units	1-9	1-12	1-15

AOU36RLAVM4, AOU48RLAVM4, AOU60RLAVM4



NEW

Specifications

Nominal System Capacity		Ton(s)	3	4	5
Model Name			AOU36RLAVM4	AOU48RLAVM4	AOU60RLAVM4
Indoor unit connectable capacity ratio			50% to 150%		
Maximum Connectable Indoor Units			1-9	1-12	1-15
Power source			208 / 230 VAC, 1-Phase, 60Hz		
Cooling capacity	Capacity	Btu/h	36,000	48,000	60,000
(Non-Ducted/Ducted)	EER	Btu/h/W	13.3 / 12.5	12.5 / 11.8	10.8 / 10.4
	SEER	-	19.0 / 17.0	19.8 / 18.1	18.5 / 16.5
Heating capacity	Capacity	Btu/h	42,000	54,000	66,000
(Non-Ducted/Ducted)	COP	W/W	3.82 / 3.86	3.88 / 3.64	3.64 / 3.60
	HSPF	-	11.50 / 10.00	11.10 / 10.40	11.00 / 10.50
Airflow rate	Cooling *Heating (J-IV only)	CFM (m3/h)	3,649 (6,200) *3,649 (6,200)	3,767 (6,400) *3,767 (6,400)	4,827 (8,200) *4,002 (6,800)
Sound pressure level	Cooling / Heating	db(A)	50 / 52	51 / 53	57 / 57
Dimensions	HxDxW	in. (mm)	52-1/2 × 38-3/16 × 14-9/16 (1,334 × 970 × 370)		
Weight		lbs.(kg)	262 (119)	265 (120)	271 (123)
Connection pipe diameter	Liquid	in. (mm)	3/8 (9.52)		
	Gas		5/8 (15.88)	5/8 (15.88)	3/4 (19.05)
Max.total pipe length		ft. (m)	590 (180)		
Max.actual pipe length (OU to furthest IU)			394 (120)		
Max.height difference (OU:Upper / Lower)			164 (50) / 131 (40)		
Operation range	Cooling	°F (°C)	23 - 115 (-5 - 46)		
	Heating	°F (°C)	-15 - 70 (-26 - 21)		
Refrigerant type			R410A		

Dimensions

(Units: in (mm))

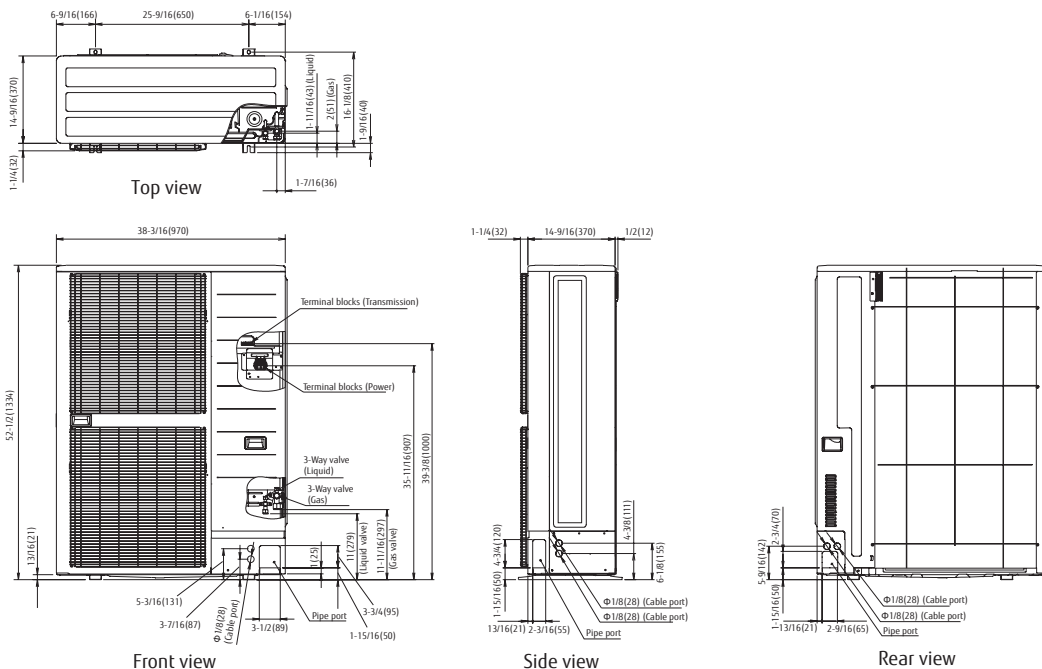

Heat Pump

Single phase 208/230V
3, 4 Ton

AIRSTAGE™ J-IVS

System configuration example

- This system is used for small and medium-sized buildings.
- Connection of multiple indoor units using separation tubes and headers.
- Up to 12 indoor units to one outdoor unit.

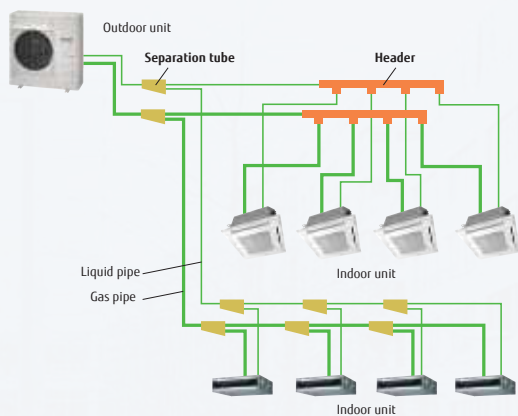

Expanded Heating Operation Range

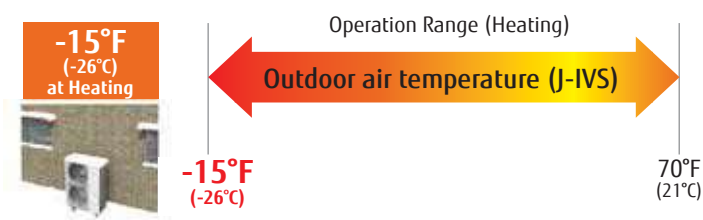

Breaker size optimized

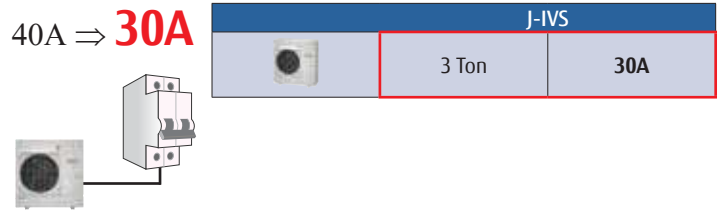

Intelligent refrigerant control

The intelligent refrigerant control provides improved comfort for people and energy-efficient operation.

External static pressure

Increased installation flexibility with available external static pressure up to 0.10 in WG.



Advanced high efficiency technology

Large and efficient propeller fan
Efficient high performance fan with low sound level.

DC fan motor
Low sound level, high efficiency multi-stage DC fan motor.

Large efficient heat exchanger
High efficiency 3-row heat exchanger.

Smooth airflow grille
Exhaust grille designed with minimum pressure loss.

Built-in Basepan Heater

Efficient DC Inverter control
Improved efficiency with active filter module

Compact and high performance DC twin rotary compressor
DC twin rotary compressor for high efficiency in all load situations

High efficiency compressor motor
Optimized refrigerant flow design

Compressor efficiency vs. Compressor capacity graph showing efficiency remains high across the capacity range up to 100%.

Easy to install

Low weight and small space requirements.

Low sound level design

Low sound levels due to inverter DC twin rotary compressor and advanced air flow technology.

Long piping length

Fujitsu advanced refrigerant control technology allows a total refrigerant piping length of 262 ft.

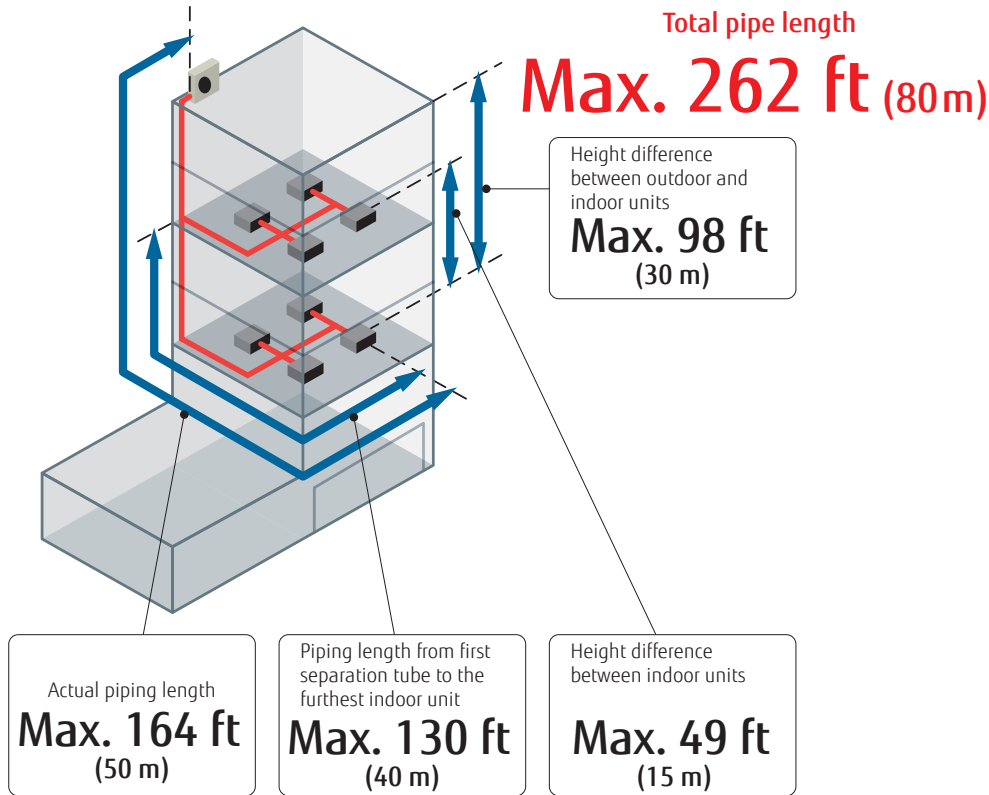

Non-stop oil recovery operation

Room comfort is kept with continuous heating and cooling even during the brief oil return operation.

Small and light weight outdoor unit

Very compact and light weight design. Can be installed on balcony, patio or below windows.

J-IVS Series

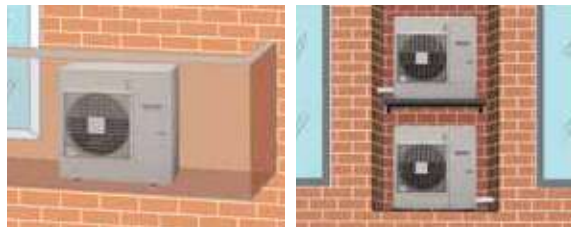

Non-stop oil recovery operation

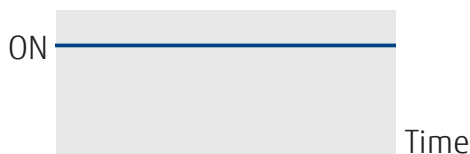

Up to 12 Indoor Units can be connected to one system

Model	J-IVS	
	Nominal System Capacity (tons)	3
Connectable indoor units	1-9	1-12

Heat Pump

3 Phase, 208-230V
6, 8, 10 Ton

AIRSTAGE® J-III L

The industry-leading Airstage J-III L system is perfect for multi-family, large residential, light commercial and commercial buildings. The unique and compact design makes the outdoor unit ideal for buildings with limited installation space. Up to 30 indoor units can be connected to one outdoor unit.



Slim & Compact Design

The compact and slim design of the J-III L series makes it ideal for buildings with limited installation space.



Interior Installation



Quiet operation does not disturb residents
Low sound level operation enables installation in any environment.

Installation in Alleys



AIRSTAGE™ J-Series outdoor unit



AIRSTAGE™ V-Series outdoor unit

Space saving
Space-saving design to fit in tight areas on the ground, on patios/balconies or on the wall.

Curbside Installation



AIRSTAGE™ J-Series outdoor unit



AIRSTAGE™ V-Series outdoor unit

Flexible installation
Slim and compact design enable outdoor units to be installed beneath windows

Flexible system configuration

Up to 30 indoor units can be connected to one outdoor unit

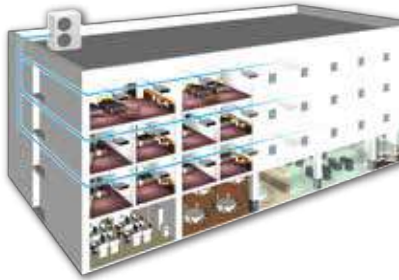

Max. connectable Indoor Unit

10Ton : 30 units
 8Ton : 24 units
 6Ton : 18 units

Low sound level design

Low sound levels due to inverter DC twin rotary compressor and advanced air flow technology.

Sound levels as low as **54 dB(A)**



J-III L

High Static Pressure

Increased installation flexibility with available external static pressure up to 0.24in. W.G (60Pa).

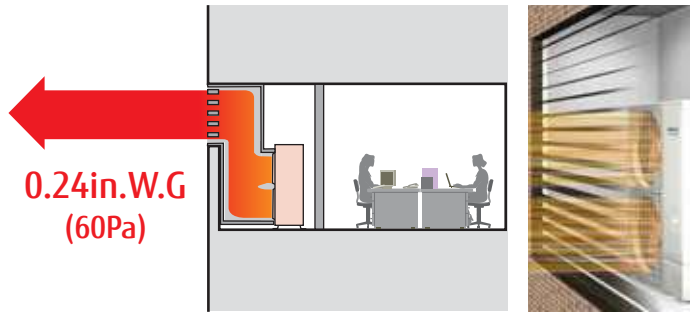

Indoor unit and controller connectivity



Wall Mounted Mini Duct Compact Cassette Compact Floor

JIII-L outdoor units can connect to:

- 14 types of indoor units - 58 different models (Capacity ranges from 4,000 to 96,000 BTUh)
- Wi-fi enabled controllers



Installation Flexibility

Long Piping Length

Fujitsu advanced refrigerant control technology allows a total refrigerant piping length of 1312 ft.

Total Piping Length

Max. **1,312 ft.**
(400m)

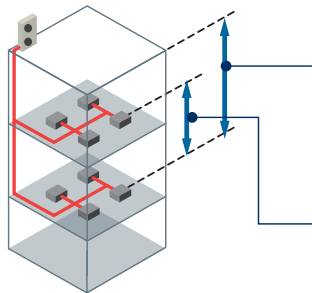

Height difference between outdoor and indoor units

Max. **164ft. (50m)**

For the outdoor unit installed below the indoor units: 131ft. (40m) max.

Height difference between indoor units

Max. **164ft. (50m)**

*: Only when new indoor units and J-III L series are combined

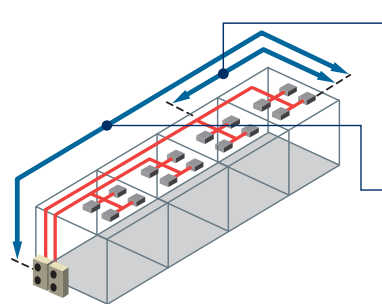

Piping length from first separation tube to the farthest indoor unit

Max. **295ft. (90m)**

Actual piping length

Max. **393ft. (120m)**

AOU72RLAVL, AOU96RLAVL, AOU120RLAVL



Specifications

Nominal system capacity		Ton	6	8	10
Model name			AOU72RLAVL	AOU96RLAVL	AOU120RLAVL
Indoor unit connectable capacity ratio			50% to 150%		
Maximum connectable indoor unit			1-18	1-24	1-30
Power source		Ø/V/Hz	208/230V, 3-Phase, 60Hz		
Capacity (Non-Ducted/Ducted)	Capacity	Btu/h	72,000	96,000	120,000
	EER	Btu/h/W	12.1/11.9	11.6/11.6	11.6/11.6
	IEER	-	23.9/21.5	23.1/21.1	24.2/20.9
Capacity (Non-Ducted/Ducted)	Capacity	Btu/h	81,000	108,000	135,000
	COP at 47°F	W/W	4.19/4.01	3.87/3.66	3.77/3.64
Airflow rate		CFM(m ³ /h)	5,298(9,000)	6,475(11,000)	7,653(13,000)
Sound pressure level	Cooling/Heating	dB(A)	54/55	59/60	62/63
	Height		64-1/2(1,638)		
	Width	in.(mm)	42-1/2(1,080)		
Dimensions		Depth	18-7/8(480)		
Weight		lbs.(kg)	470(213)		
Connection pipe diameter	Liquid	in.(mm)	3/8(9.52)	3/8(9.52)	1/2(12.70)
	Gas		3/4(19.05)	7/8(22.20)	1-1/8(28.58)
Max.Total pipe length			393(120)		
Max.height difference (Outdoor Unit: Upper/Lower)		ft.(m)	164/131(50/40)		
Operation range	Cooling	°F(°C)	5*1 to 115 (-15*1 to 46)	5*1 to 115 (-15*1 to 46)	23*1,2 to 115 (-5*1,2 to 46)
	Heating		-4 to 70(-20 to 21)	-4 to 70(-20 to 21)	-4 to 70(-20 to 21)
Refrigerant type			R410A		

Note: Specifications are based on the following conditions: Cooling: Indoor temperature of 80°F (26.7°C)DB / 67°F (19.4°C) WB, and outdoor temperature of 95°F (35°C)DB / 75°F (23.9°C)WB. Heating: Indoor temperature of 70°F (21.1°C)DB / 60°F (15.6°C)WB, and outdoor temperature of 47°F (8.3°C)DB / 43°F (6.1°C)WB. Pipe length: 25ft. (7.5m), Height difference: 0ft. (0m). (Outdoor unit - indoor unit)

*1 When the outdoor unit is lower than the indoor unit, the temperature range is 23°F(-5°C).
 *2 The cooling operation range of 5 to 115°F(-15 to 46°C) is allowed only when all of the indoor units connected to the system are higher than capacity of 18000Btu/h(5.6kW).

Dimensions

(Units: in (mm))

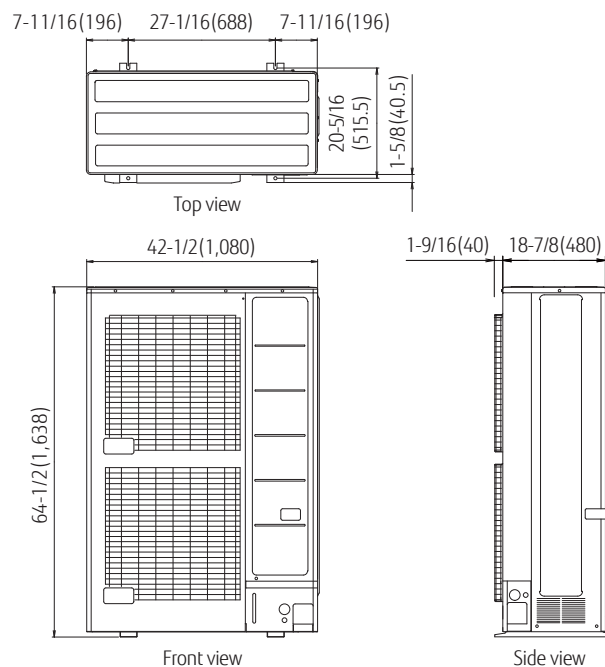

Heat Pump

3 Phase , 208/230V, 460V
6 to 24 tons

AIRSTAGE V-II

System configuration example

- This system is used for medium-sized and large buildings.
- Connection of up to 63 indoor units to one outdoor unit.

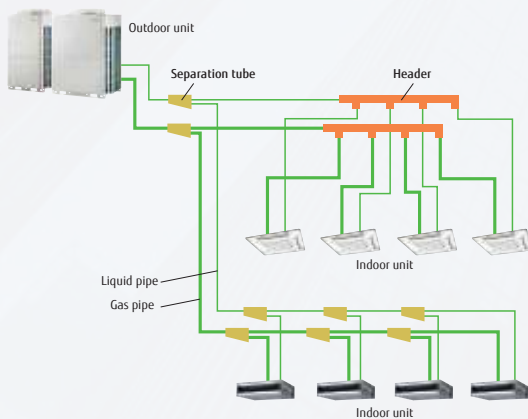

Energy saving technology that boosts operation efficiency

- Fujitsu's Airstage VRF systems features advanced technology to provide comfort control, energy efficiency and reliability. Excellent for heating or cooling of multi-family residential to large commercial buildings.
- Extensive system lineup with capacities from 6 to 24 Tons in 2-Ton increments
- Connectable indoor unit capacity ratio up to 150%
- Airstage systems can be connected to a single VRF communication network offering a variety of central and remote communication and BMS options.

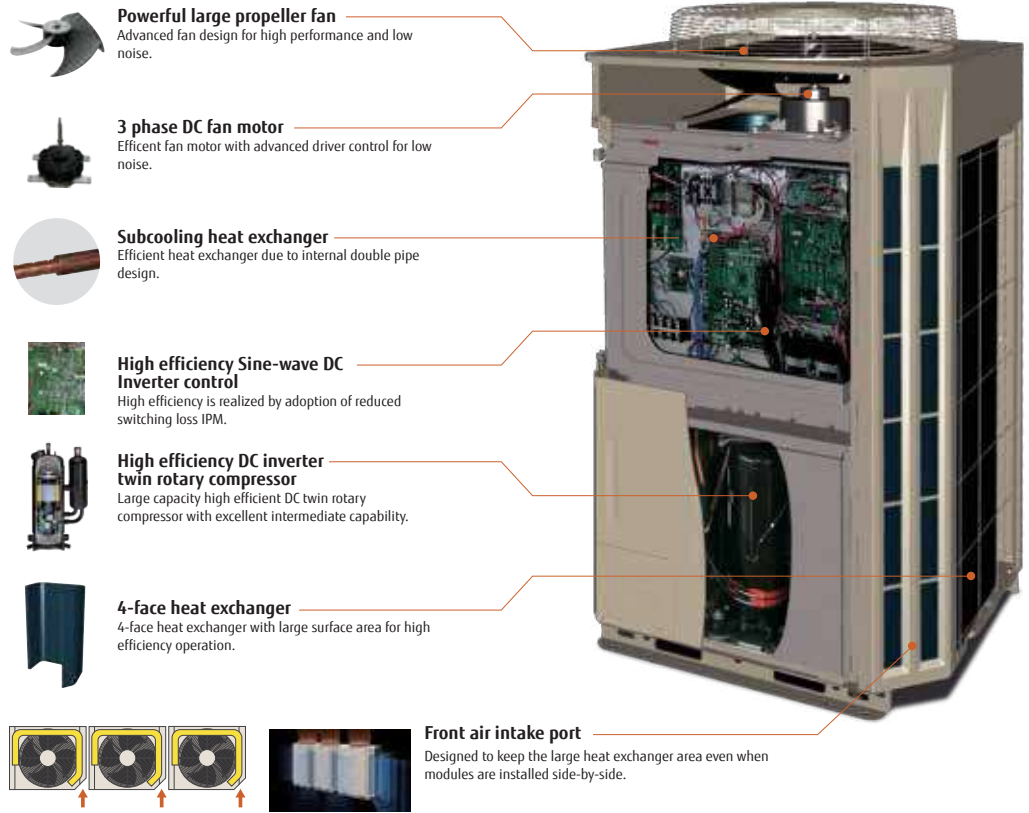

System Outline

Excellent energy savings

Advanced inverter control improves system operation efficiency, even in part-load conditions.

Multiple outdoor operation control

Airstage system with multiple outdoor units connected together utilizes an advanced control technology so the all compressors are operating at part load, instead of running fewer compressors at full load. This allows the compressors to operate at their maximum efficiency while utilizing all the heat exchanger area to increase the overall system efficiency.

Expanded Heating Operation Range

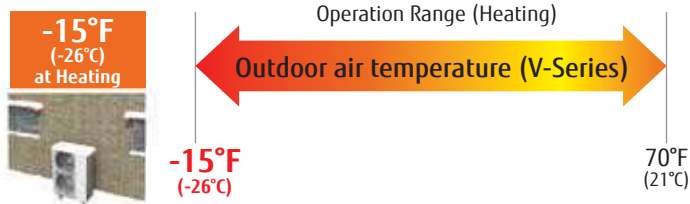

Heat exchanger refrigerant control

The heat exchanger in the outdoor unit is split into two parts. The overall efficiency of the heat exchanger has been improved by adopting an optimum refrigerant path control.

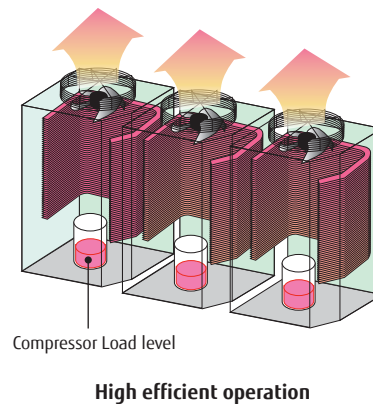



6-8 ton

10 ton

Note :

Specifications are based on the following conditions.

Cooling :

Indoor temperature of 80°F (26.7°C) DB / 67°F (19.4°C) WB, and outdoor temperature of 95°F (35.0°C) DB / 75°F (23.9°C) WB.

Heating :

Indoor temperature of 70°F (21.1°C) DB / 60°F (15.6°C) WB, and outdoor temperature of 47°F (8.3°C) DB / 43°F (6.1°C) WB.

Pipe length :

25ft. (7.5 m); Height difference between outdoor unit and indoor unit : 0ft. (0 m).

*1 Electrical data is only for outdoor unit.

VRF Communication Cable is required. It is shown on pg. 113

16	18	20	22	24
AOUA192RLBVG / RLBVG1 AOUA192RLCVG	AOUA216RLBVG / RLBVG1 AOUA216RLCVG	AOUA240RLBVG / RLBVG1 AOUA240RLCVG	AOUA264RLBVG / RLBVG1 AOUA264RLCVG	AOUA288RLBVG / RLBVG1 AOUA288RLCVG
1×(AOUA120RLBV1) + 1×(AOUA72RLBV1) / 1×(AOUA120RLCV) + 1×(AOUA72RLCV)	1×(AOUA120RLBV1) + 1×(AOUA96RLBV1) / 1×(AOUA120RLCV) + 1×(AOUA96RLCV)	2×(AOUA120RLBV1) / 2×(AOUA120RLCV)	2×(AOUA96RLBV1) + 1×(AOUA72RLBV1) / 2×(AOUA96RLCV) + 1×(AOUA72RLCV)	3×(AOUA96RLBV1) / 3×(AOUA96RLCV)
50% to 150%				
42	47	52	58	63
192,000 [56.2]	216,000 [63.3]	240,000 [70.3]	264,000 [77.4]	288,000 [84.4]
16.04	18.47	20.45	22.58	25.27
216,000 [63.3]	243,000 [71.2]	270,000 [79.1]	297,000 [87.0]	324,000 [95.0]
15.65	19.07	21.9	23.41	26.28
208 / 230 VAC, 3-Phase, 60Hz / 460 VAC, 3-Phase, 60Hz				
1×(50),1×(60) / 1×(25), 1×(30)	1×(50),1×(60) / 1×(25), 1×(30)	2×(60) / 2×(30)	3×(50) / 3×(25)	3×(50) / 3×(25)
1X (41), 1X (50) / 1X (21), 1X (25)	1X (41), 1X (50) / 1X (21), 1X (25)	2X (50) / 2X (25)	3X (41) / 3X (21)	3X (41) / 3X (21)
11.2 / 11.1	10.9 / 10.9	10.9 / 10.9	10.9 / 10.9	10.6 / 10.6
24.3 / 20.5	20.0 / 19.2	20.8 / 20.2	20.8 / 20.1	20.8 / 20.1
3.75 / 3.57	3.47 / 3.47	3.36 / 3.36	3.45 / 3.40	3.36 / 3.31
23 to 115 [-5 to 46]	23 to 115 [-5 to 46]	23 to 115 [-5 to 46]	23 to 115 [-5 to 46]	23 to 115 [-5 to 46]
-15 to 70 [-26 to 21]	-15 to 70 [-26 to 21]	-15 to 70 [-26 to 21]	-15 to 70 [-26 to 21]	-15 to 70 [-26 to 21]
5/8 [15.88]	5/8 [15.88]	5/8 [15.88]	5/8 [15.88]	3/4 [19.05]
1-1/8 [28.58]	1-3/8 [34.92]	1-3/8 [34.92]	1-3/8 [34.92]	1-3/8 [34.92]
R410A	R410A	R410A	R410A	R410A
1×(25.79[11.70]) + 1×(26.01[11.80])	1×(25.79[11.70]) + 1×(26.01[11.80])	2×(26.01[11.80])	3×(25.79[11.70])	3×(25.79[11.70])
1×(6533 [11,100]) + 1×(7652 [13,000])	1×(6533 [11,100]) + 1×(7652 [13,000])	2×(7652 [13,000])	3×(6533 [11,100])	3×(6533 [11,100])
0.32 [80]	0.32 [80]	0.32 [80]	0.32 [80]	0.32 [80]
62/63	63/64	64/65	63/63	64/64
2×Rotary Inverter	2×Rotary Inverter	2×Rotary Inverter	3×Rotary Inverter	3×Rotary Inverter
1×(7.5)+1×(11.0)	1×(7.5)+1×(11.0)	2×11.0	3×7.5	3×7.5
2×(2×35)	2×(2×35)	2×(2×35)	3×(2×35)	3×(2×35)
1×(66-9/16 × 36-5/8 × 30-1/8 [1,690 × 930 × 765]), 1×(66-9/16 × 48-13/16 × 30-1/8 [1,690 × 1240 × 765])	1×(66-9/16 × 36-5/8 × 30-1/8 [1,690 × 930 × 765]), 1×(66-9/16 × 48-13/16 × 30-1/8 [1,690 × 1240 × 765])	2×(66-9/16 × 48-13/16 × 30-1/8 [1,690 × 1240 × 765])	3×(66-9/16 × 36-5/8 × 30-1/8 [1,690 × 930 × 765])	3×(66-9/16 × 36-5/8 × 30-1/8 [1,690 × 930 × 765])
564[256]+611[277] / 635[288]+584[265]	564[256]+611[277] / 635[288]+584[265]	2×([611[277]] / 2×(635[288]))	3×([564[256]] / 3×(584[265]))	3×([564[256]] / 3×(584[265]))

10tons: AOUA120RLBV1
AOUA120RLCV

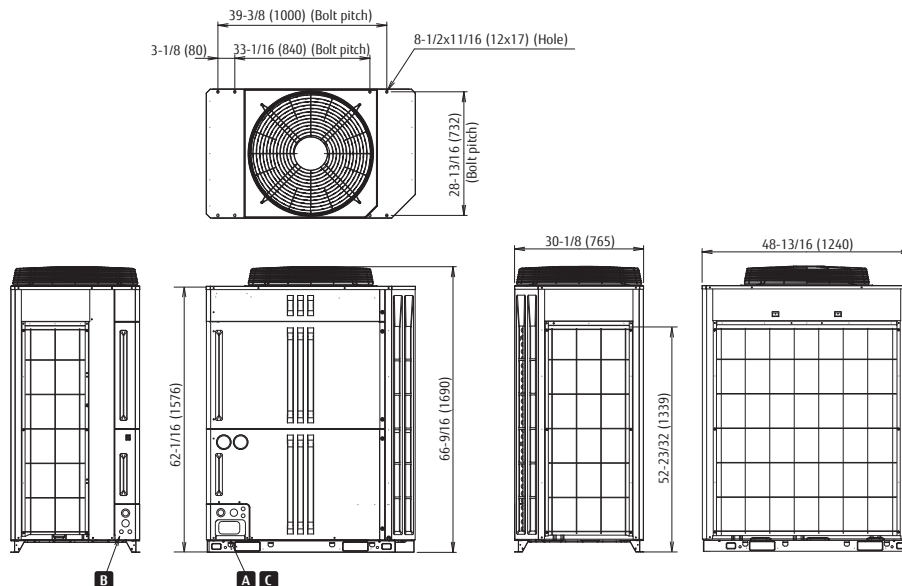

Heat Recovery

3 Phase , 208/230V, 460V
6 to 24 tons

AIRSTAGE® VR-II

Energy efficient, meet any individual cooling/ heating need from each space.

Benefits



Simultaneous cooling and heating operation from one refrigerant system



Lower life-cycle cost

The total life cycle cost of a Fujitsu Airstage system is very low due to the great energy efficiency, high quality and features such as easy to design, install, and maintain.



Always comfortable

Advanced controls react fast to demand changes to always keep the climate comfortable.

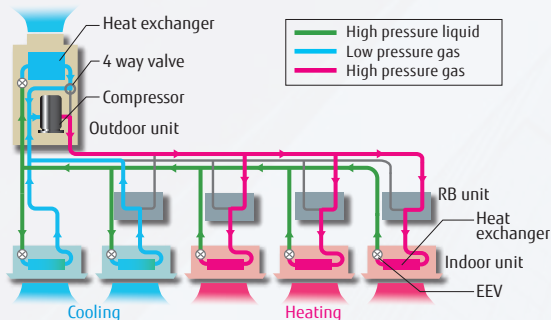

Airstage heat recovery systems offer efficient climate control by extracting heat from rooms/zones that require cooling and transferring the heat to other rooms/zones that at the same time require heating. This creates maximum comfort in all areas while optimizing energy efficiency.

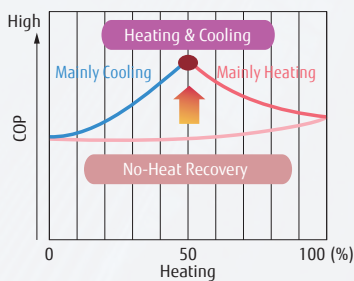

Large Building



Flexible piping layout

Fujitsu's outdoor units, indoor units, headers/separation tubes and RBU's make it possible to design the VRF system to any floorplan and building structure.

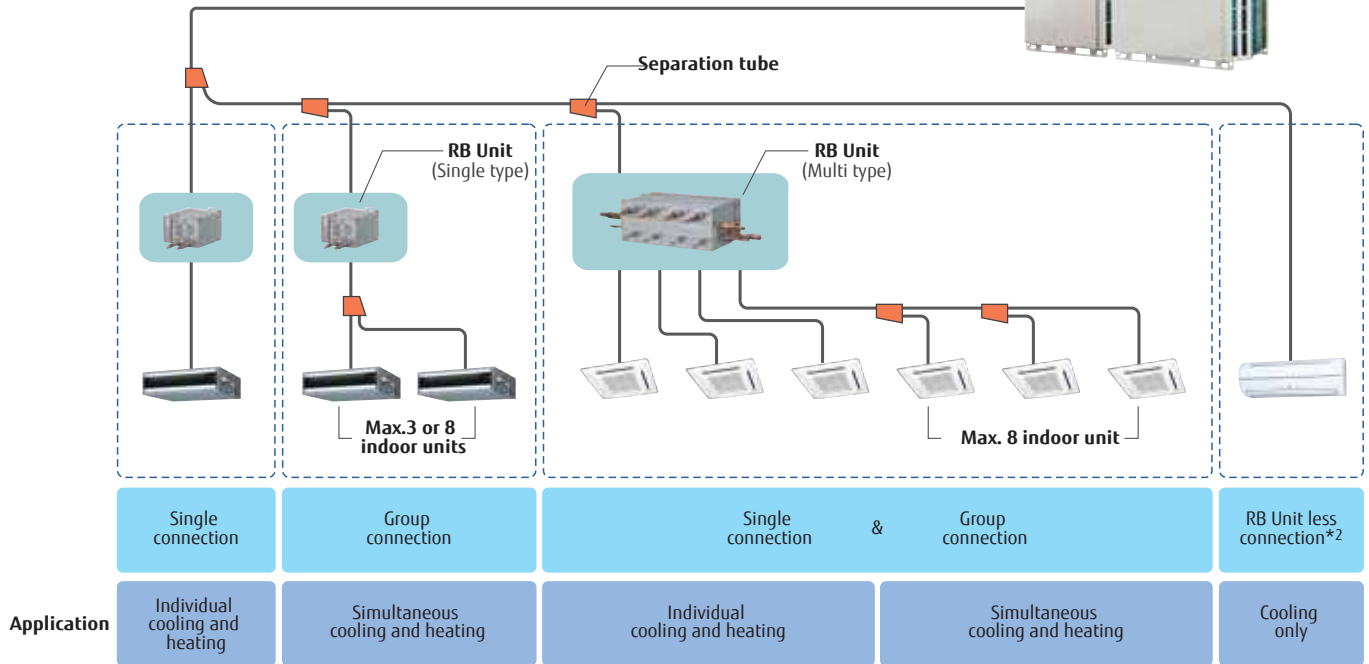

Flexible installation of Refrigerant Branch (RB) unit

See specifications of RB units on pg 115.

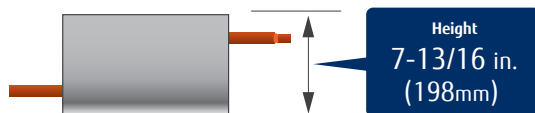

- Compact and low design saves space and increases installation flexibility.
- No drain or condensate consideration is required.
- Flexible with several alternative positions for the control box on the single port RB unit.



Single RBUs offer flexible installation orientation to accommodate space requirements.

Simple installation series connection design

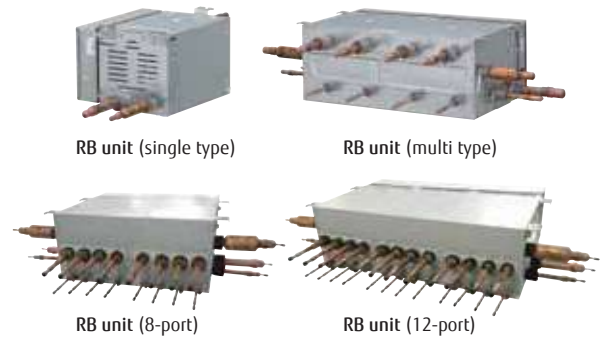
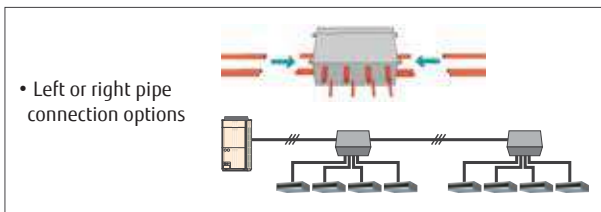

Easy to service in a narrow space.

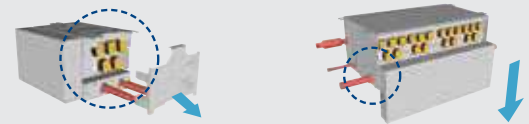

- Maintenance can be performed from the side.
- No top-access service needed.
- Electronics enclosure can slide open for temporary service access.

- Service friendly design, allows service even in tight spaces

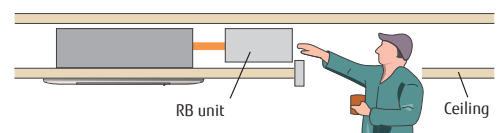

OUTDOOR UNITS

VR-II Specifications for 208 / 230 / 460V

Nominal Tonnage	Ton(s)	6	8	10	12	14
Model Name	Units	AOUA72TLBV AOUA72LCV	AOUA96TLBV AOUA96LCV	AOUA120TLBV / AOUA120LCV	AOUA144TLBV / AOUA144LCV	AOUA168TLBV / AOUA168LCV
Unit Group Configuration		1×(AOUA72TLBV) 1×(AOUA72LCV)	1×(AOUA96TLBV) 1×(AOUA96LCV)	1×(AOUA120TLBV) 1×(AOUA120LCV)	2×(AOUA72TLBV) 2×(AOUA72LCV)	1×(AOUA72TLBV) + 1×(AOUA96TLBV) 1×(AOUA72LCV) + 1×(AOUA96LCV)
Indoor Unit Total Capacity		50% to 150%				
Maximum Connectable Indoor Units		14	16	18	22	26
CAPACITY						
Nominal Cooling Capacity	BTUh [kW]	72,000 [21.1]	96,000 [28.1]	120,000 [35.2]	144,000 [42.2]	168,000 [49.2]
Cooling Power Input (Nominal)	kW	5.31	7.56	9.75	11.69	14.03
Nominal Heating Capacity	BTUh [kW]	81,000 [23.7]	108,000 [31.7]	135,000 [39.6]	162,000 [47.5]	188,000 [55.1]
Heating Power Input (Nominal)	kW	5.35	7.82	10.11	12.73	13.93
ELECTRIC						
Electrical Power Requirements		208 / 230 VAC, 3-Phase, 60Hz / 460 VAC, 3-Phase, 60Hz				
Maximum Circuit Breaker	A	50 / 25	50 / 25	60 / 30	2×(50) / 2×(25)	2×(50) / 2×(25)
Minimum Circuit Ampacity (MCA)	A	41 / 21	41 / 21	50 / 25	2X (41) / 2X (21)	2X (41) / 2X (21)
EFFICIENCY						
Cooling (Non-Ducted/Ducted)	EER	12.5 / 12.3	11.7 / 11.3	11.3 / 11.3	11.4 / 11.4	11 / 11
Cooling (Non-Ducted/Ducted)	IEER	24.1 / 20	23.6 / 20.20	23.8 / 20.1	22.2 / 20.4	22.2 / 20
Heating 47° (Non-Ducted/Ducted)	COP	4.06 / 3.64	3.72 / 3.60	3.61 / 3.49	3.44 / 3.44	3.48 / 3.48
SCHE (Non-Ducted/Ducted)	SCHE	30.1 / 24.00	26.5 / 25.5	25.4 / 25.8	22.2 / 22.2	22 / 22
TEMPERATURE						
Operating Temp. Cooling (DB)	°F [°C]	14 to 115 [-10 to 46]	14 to 115 [-10 to 46]	14 to 115 [-10 to 46]	14 to 115 [-10 to 46]	14 to 115 [-10 to 46]
Operating Temp. Heating (DB)	°F [°C]	-14 to 70 [-26 to 21]	-15 to 70 [-26 to 21]	-15 to 70 [-26 to 21]	-15 to 70 [-26 to 21]	-15 to 70 [-26 to 21]
PIPE						
Pipe Connection: Liquid	in [mm]	1/2 [12.70]	1/2 [12.70]	1/2 [12.70]	1/2 [12.70]	5/8 [15.88]
Pipe Connection: Discharge Gas	in [mm]	5/8 [15.88]	3/4 [19.05]	3/4 [19.05]	7/8 [22.22]	7/8 [22.22]
Pipe Connection: Suction Gas	in [mm]	7/8 [22.22]	7/8 [22.22]	1-1/8 [28.58]	1-1/8 [28.58]	1-1/8 [28.58]
REFRIGERANT						
Refrigerant Type		R410A	R410A	R410A	R410A	R410A
Refrigerant Charge	lbs [kg]	26.01 [11.80]	26.01 [11.80]	26.01 [11.80]	2×(26.01 [11.80])	2×(26.01 [11.80])
FAN						
Fan Airflow Rate	CFM [m³/h]	6533 [11,100]	6533 [11,100]	7652 [13,000]	2×(6533 [11,100])	2×(6533 [11,100])
External Static Pressure (Max)	in.WG [Pa]	0.32 [80]	0.32 [80]	0.32 [80]	0.32 [80]	0.32 [80]
Sound Pressure Levels (Cq/Ht q)	dB (A)	57/58	59 / 59	61 / 62	60/61	61/62
COMPRESSOR						
Compressor Type x Quantity		Rotary Inverter	Rotary Inverter	Rotary Inverter	2×Rotary Inverter	2×Rotary Inverter
Compressor Motor Output	kW	7.5	7.5	11	2×7.5	2×7.5
Compressor Crankcase Heater	W	2×35	2×35	2×35	2×(2×35)	2×(2×35)
DIMENSIONS / WEIGHT						
Dim.Net (HxWxD)	in [mm]	66-9/16 × 36-5/8 × 30-1/8 [1,690 × 930 × 765]	66-9/16 × 36-5/8 × 30-1/8 [1,690 × 930 × 765]	66-9/16 × 48-13/16 × 30-1/8 [1,690 × 1240 × 765]	2 × (66-9/16 × 36-5/8 × 30-1/8 [1,690 × 930 × 765])	2 × (66-9/16 × 36-5/8 × 30-1/8 [1,690 × 930 × 765])
Net Weight	lbs [kg]	597 [271] / 609 [276]	597 [271] / 609 [276]	639 [290] / 657 [298]	2X (597 [271]) / 2X (609 [276])	2X (597 [271]) / 2X (609 [276])

Dimensions

(Units: in (mm))

**6, 8 tons: AOUA72RLBV1 / AOUA96RLBV1
AOUA72RLCV / AOUA96RLCV**

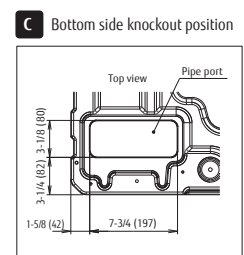
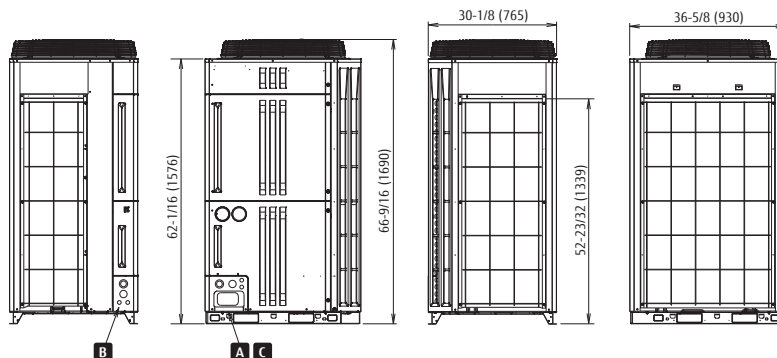
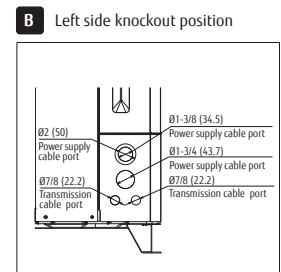
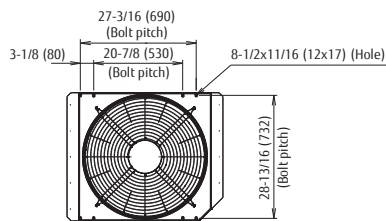
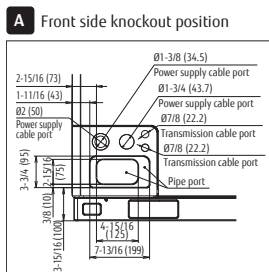

16	18	20	22	24
AOUA192TLBVG / AOUA192TLCVG	AOUA216TLBVG / AOUA216TLCVG	AOUA240TLBVG / AOUA240TLCVG	AOUA264TLBVG / AOUA264TLCVG	AOUA288TLBVG / AOUA288TLCVG
1×(AOUA72TLBV) + 1×(AOUA120TLBV) + 1×(AOUA72TLCV) + 1×(AOUA120TLCV)	1×(AOUA96TLBV) + 1×(AOUA120TLBV) + 1×(AOUA96TLCV) + 1×(AOUA120TLCV)	2×(AOUA120TLBV) + 2×(AOUA120TLCV)	1×(AOUA72TLBV) + 2×(AOUA96TLBV) + 1×(AOUA72TLCV) + 2×(AOUA96TLCV)	3×(AOUA96TLBV) + 3×(AOUA96TLCV)
50% to 150%				
30	34	37	41	45
192,000 [56.2]	216,000 [63.3]	240,000 [70.3]	264,000 [77.4]	288,000 [84.4]
15.78	18.27	20.19	22.35	25
216,000 [63.3]	243,000 [71.2]	270,000 [79.1]	297,000 [87.0]	324,000 [95]
14.79	18.91	21.7	23.2	26.07
208 / 230 VAC, 3-Phase, 60Hz / 460 VAC, 3-Phase, 60Hz				
1×(50), 1×(60) / 1×(25), 1×(30)	1×(50), 1×(60) / 1×(25), 1×(30)	2×(60) / 2×(30)	2×(50), 1×(60) / 3×(25)	3×(50) / 3×(25)
1X (41), 1X (50) / 1X (21), 1X (25)	1X (41), 1X (50) / 1X (21), 1X (25)	2X (50) / 2X (25)	3X (41) / 3X (21)	3X (41) / 3X (21)
11.2 / 11.1	10.9 / 10.9	10.9 / 10.9	10.9 / 10.9	10.6 / 10.6
24.3 / 20.5	20 / 19.2	20.8 / 20.2	20.8 / 20.1	20.8 / 20.1
3.75 / 3.57	3.47 / 3.47	3.36 / 3.36	3.45 / 3.4	3.36 / 3.31
27.1 / 25	25.2 / 25.2	23.7 / 23.7	22.0 / 22.0	22.0 / 22.0
14 to 115 [-10 to 46] -15 to 70 [-26 to 21]	14 to 115 [-10 to 46] -15 to 70 [-26 to 21]	14 to 115 [-10 to 46] -15 to 70 [-26 to 21]	14 to 115 [-10 to 46] -15 to 70 [-26 to 21]	14 to 115 [-10 to 46] -15 to 70 [-26 to 21]
5/8 [15.88]	5/8 [15.88]	5/8 [15.88]	5/8 [15.88]	3/4 [19.05]
7/8 [22.22]	1-1/8 [28.58]	1-1/8 [28.58]	1-1/8 [28.58]	1-1/8 [28.58]
1-1/8 [28.58]	1-3/8 [34.92]	1-3/8 [34.92]	1-3/8 [34.92]	1-3/8 [34.92]
R410A	R410A	R410A	R410A	R410A
2×(26.01 [11.80])	2×(26.01 [11.80])	2×(26.01 [11.80])	3×(26.01 [11.80])	3×(26.01 [11.80])
1×(6533 [11,100]) + 1×(7652 [13,000])	1×(6533 [11,100]) + 1×(7652 [13,000])	2×(7652 [13,000])	3×(6533 [11,100])	3×(6533 [11,100])
0.32 [80]	0.32 [80]	0.32 [80]	0.32 [80]	0.32 [80]
62 / 63	63/64	64/65	63/63	64/64
2×Rotary Inverter	2×Rotary Inverter	2×Rotary Inverter	3×Rotary Inverter	3×Rotary Inverter
1×(7.5) + 1×(11)	1×(7.5) + 1×(11)	2×(11)	3×7.5	3×7.5
2×(2×35)	2×(2×35)	2×(2×35)	3×(2×35)	3×(2×35)
1×(66-9/16 × 36-5/8 × 30-1/8 [1,690 × 930 × 765]), 1×(66-9/16 × 48-13/16 × 30-1/8 [1,690 × 1240 × 765])	1×(66-9/16 × 36-5/8 × 30-1/8 [1,690 × 930 × 765]), 1×(66-9/16 × 48-13/16 × 30-1/8 [1,690 × 1240 × 765])	2×(66-9/16 × 48-13/16 × 30-1/8 [1,690 × 1240 × 765])	3×(66-9/16 × 36-5/8 × 30-1/8 [1,690 × 930 × 765])	3×(66-9/16 × 36-5/8 × 30-1/8 [1,690 × 930 × 765])
1X (597 [271]), 1X (639 [290]) / 1X (609 [276]), 1X (657 [298])	1X (597 [271]), 1X (639 [290]) / 1X (609 [276]), 1X (657 [298])	2X (639 [290]) / 2X (657 [298])	3X (584 [265]) 3X (597 [271]) / 3X (609 [276])	3X (597 [271]) / 3X (609 [276])

Note :
Specifications are based on the following conditions:

Cooling :
Indoor temperature of 80°F (26.7°C) DB / 67°F (19.4°C) WB, and outdoor temperature of 95°F (35.0°C) DB / 75°F (23.9°C) WB.

Heating :
Indoor temperature of 70°F (21.1°C) DB / 60°F (15.6°C) WB, and outdoor temperature of 47°F (8.3°C) DB / 43°F (6.1°C) WB.

Pipe length :
25ft. (7.5 m); Height difference between outdoor unit and indoor unit : 0ft. (0 m).

*1 Electrical data is only for outdoor unit.

**10 tons: AOUA120RLBV1
AOUA120RLCV**

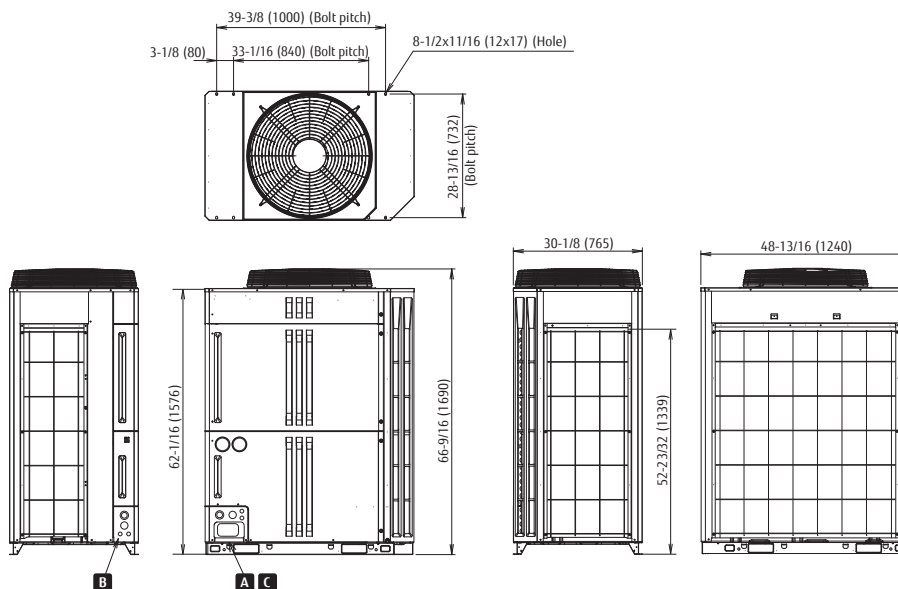

VRF INDOOR UNITS

The Fujitsu Airstage indoor unit range is one of the widest on the market, offering 14 stylish and elegant indoor unit types in 53 different models. All designed to blend into any environment, maximize comfort, minimize operating sound and simplify installation and servicing.

- p. 46 Compact Cassette
- p. 48 Large Circular Flow Cassette
- p. 50 Large 4-way Cassette
- p. 52 Slim Compact Duct
- p. 54 Medium Static Pressure Duct
- p. 56 High Static Pressure Duct (ARUH36, 48, 60)
- p. 58 High Static Pressure Duct (ARUH72, 96)
- p. 60 Multi-Position Air Handling Unit
- p. 62 Floor Mount
- p. 64 Floor/Ceiling
- p. 66 Ceiling
- p. 68 Compact Wall Mounted
- p. 70 Wall Mounted



Compact Cassette

- AUUA4TLAV2 AUUA14RLAV / TLAV2
- AUUA7RLAV / TLAV2 AUUA18TLAV2
- AUUA9RLAV / TLAV2 AUUA24RLAV / TLAV2
- AUUA12RLAV / TLAV2



Compact size panel design that fits in a standard 24" square ceiling panel (600 x 600mm)

Note: IR Receiver is standard for communicating with optional Wireless Remote Control.
Compact Cassette Grille UTG-CCGVG sold separately. Must order one with each compact cassette.

2-stage turbo fan

2-stage fan design for high efficiency

High efficiency heat transfer due to 2 stage turbo fan with dual airflow for even air distribution across the heat exchanger.

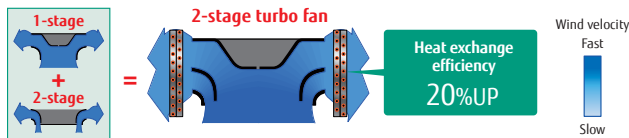

Quiet

Optimized fan blade design for low noise and high performance

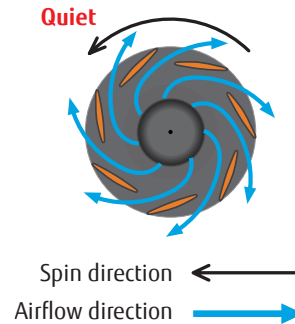

Specifications

Model		AUUA4TLAV2	AUUA7RLAV / TLAV2	AUUA9RLAV / TLAV2	AUUA12RLAV / TLAV2	AUUA14RLAV / TLAV2	AUUA18TLAV2	AUUA24RLAV / TLAV2	
Power source		1 Phase - 208/230V 60Hz							
Capacity	Cooling	BTUh	4,000	7,500	9,500	12,000	14,000	18,000	24,000
		kW	1.2	2.2	2.8	3.5	4.1	5.3	7.0
	Heating	BTUh	4,400	9,500	10,900	13,500	15,600	20,000	27,000
		kW	1.3	2.8	3.2	4.0	4.6	5.9	7.9
Input power		W	23	25	25	29	35	36	84
Airflow rate	High	CFM (m ³ /h)	312 (530)	318 (540)	324 (550)	353 (600)	400 (680)	418 (710)	606 (1,030)
	Med		265 (450) / 247 (420)	265 (450)	265 (450)	312 (530)	347 (590)	341 (580)	489 (830)
	Low		206 (350) / 177 (300)	206 (350)	206 (350)	230 (390)	230 (390)	235 (400)	265 (450)
Sound pressure level	High	dB (A)	34	34	35	37	38	41	50
	Med		30 / 28	30	30	34	34	35	44
	Low		25 / 21	25	25	27	27	27	30
Dimensions (H x W x D)		in. (mm)	9-5/8 x 22-7/16 x 22-7/16 (245 x 570 x 570)						
Weight		lbs. (kg)	32 (14.5)	33 (15)	33 (15)	33 (15)	33 (15)	37 (17)	37 (17)
Connection pipe diameter	Liquid (Flare)	in. (mm)	1/4 (6.35)	1/4 (6.35)	1/4 (6.35)	1/4 (6.35)	1/4 (6.35)	3/8 (9.52)	3/8 (9.52)
	Gas (Flare)		3/8 (9.52)	1/2 (12.70)	1/2 (12.70)	1/2 (12.70)	1/2 (12.70)	5/8 (15.88)	5/8 (15.88)
Drain hose diameter (I.D./O.U.)			3/4 / 1-1/16						
Cassette Grille	Model name		UTG-CCGVG						
	Dimensions (H×W×D)	in. (mm)	1-15/16 x 24-7/16 x 24-7/16 (49 x 620 x 620)						
	Weight	lbs. (kg)	5.1 (2.3)						

Note : Specifications are based on the following conditions.

Cooling : Indoor temperature of 80°F (26.7°C) DB/67°F (19.4°C) WB, and outdoor temperature of 95.0°F (35°C) DB/75°F (23.9°C) WB.

Heating : Indoor temperature of 70°F (21.1°C) DB/60°F (15.6°C) WB, and outdoor temperature of 47°F (8.3°C) DB/43°F (6.1°C) WB.

Pipe length : 25ft. (7.5 m), Height difference : 0ft. (0 m) (Outdoor unit - Indoor unit).

Built-in protective functions may limit capacity or shut off unit if unit is operated outside of unit design operating temperature ranges.

Optimized airflow distribution

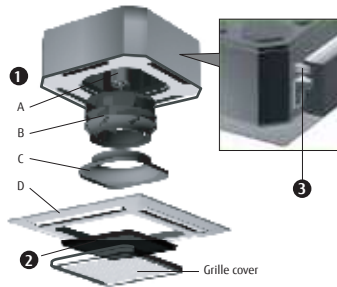

1 Easy maintenance of fan and motor

Access and maintenance of the fan and motor can easily be done removing a panel. Both fan and motor can easily be removed for repair or replacement.

A : Fan motor B : 2-stage turbo fan
C : Bell-mouth D : Grille Panel

2 Air filter

Standard equipment

3 Transparent condensate drain parts

During installation, maintenance and operation, the condensate drain pump can easily be inspected.

High lift pump

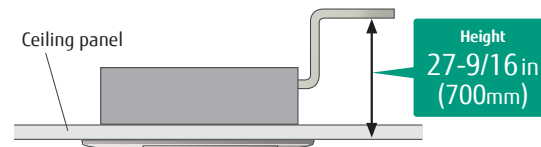

Built-in condensate drain pump

High ceiling mode

AUUA12/14/18/24TLAV models only -The compact cassette can be installed up to a height of 9'10-1/8" ft. (3.0m)

BTUh	Max height from floor to ceiling (ft.(m))	
	Standard mode	High ceiling mode
4,000	8'10-5/16" (2.7)	-
7,000	8'10-5/16" (2.7)	-
9,000	8'10-5/16" (2.7)	-
12,000	8'10-5/16" (2.7)	9'10-1/8" (3.0)
14,000	8'10-5/16" (2.7)	9'10-1/8" (3.0)
18,000	8'10-5/16" (2.7)	9'10-1/8" (3.0)
24,000	8'10-5/16" (2.7)	9'10-1/8" (3.0)

Compact design

Industry leading 24,000 BTUH model in the compact cassette category Fits standard 24" ceiling grid.



Optional parts

Wired Remote Control UTY-RNKU
Wired Remote Control (Touch Panel) UTY-RNRUZ*
Wireless Remote Control..... UTY-LNHU
Wi-Fi Interface Module FJ-RC-WIFI-INA
Simple Remote Control UTY-RSRY, UTY-RHRY
Air Outlet Shutter Plate UTR-YDZB
Fresh Air Intake Kit UTZ-VXAA
Insulation Kit for High Humidity..... UTZ-KXGC

Dimensions

(Unit: In (mm))

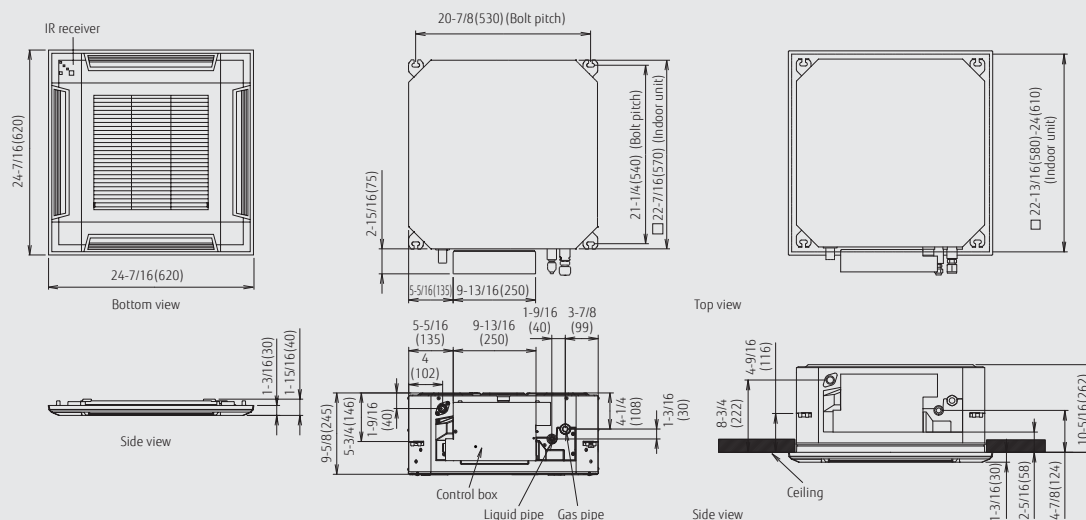

Large Circular Flow Cassette

AUUB18TLAV1 / TLAV2 (reduced height)

AUUB24TLAV1 / TLAV2 (reduced height)

AUUB30TLAV1 / TLAV2 (reduced height)

AUUB36TLAV2

AUUB48TLAV1 / TLAV2



Unique circular air flow design

Unique seamless airflow louver design with 360° air exhaust for even and comfortable temperatures anywhere in the room.

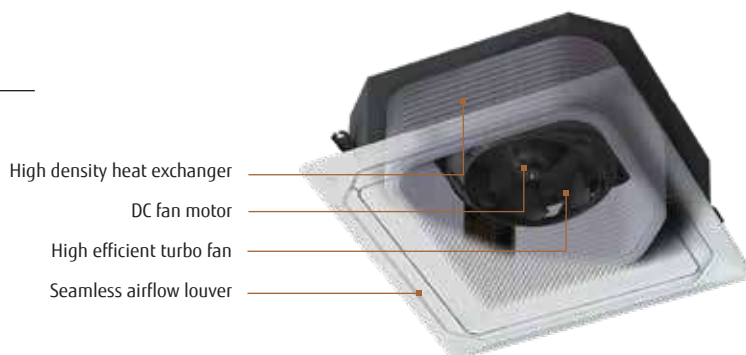

360° louvers for efficient air distribution

Circular air exhaust allows conditioned air to reach all areas of the room.



Specifications

Model name			AUUB18TLAV1 / TLAV2	AUUB24TLAV1 / TLAV2	AUUB30TLAV1 / TLAV2	AUUB36TLAV2	AUUB48TLAV1 / TLAV2
Power Source			1 Phase - 208 / 230 V ~ 60 Hz			1 Phase - 208 / 230 V ~ 60 Hz	
Capacity	Cooling	BTU/h	18,000	24,000	30,000	36,000	48,000
		kW	5.3	7.0	8.8	10.6	14.1
	Heating	BTU/h	20,000	27,000	34,000	40,000	54,000
		kW	5.9	7.9	10.0	11.7	15.8
Input Power		W	20	25	49	61	116
Airflow rate	High	CFM (m ³ /h)	618 (1,050)	659 (1,120)	865 (1,470)	954 (1,620)	1,201 (2,040)
	Med-Hi		547 (930)	618 (1,050)	683 (1,160)	883 (1,500)	1,059 (1,800)
	Med		530 (900)	547 (930)	630 (1,070)	824 (1,400)	936 (1,590)
	Lo-Hi		512 (870)	530 (900)	547 (930)	789 (1,340)	848 (1,440)
	Low		477 (810)	512 (870)	530 (900)	753 (1,280)	765 (1,300)
	Quiet		459 (780)	459 (780)	459 (780)	677 (1,150)	677 (1,150)
Sound pressure level	High	dB(A)	33	35	40	41	47
	Med-Hi		32	33	36	40	45
	Med		31	32	34	38	42
	Lo-Hi		30	31	32	37	39
	Low		29	30	31	35	36
	Quiet		28	28	28	33	33
Dimensions (H x W x D)		in.(mm)	9-11/16 x 33-1/16 x 33-1/16 (246 x 840 x 840)			11-5/16 x 33-1/16 x 33-1/16 (288 x 840 x 840)	
Weight		lbs.(kg)	53 (24)	54 (24.5)	54 (24.5)	65 (29.5)	65 (29.5)
Connection pipe diameter	Liquid (Flare)	in.(mm)	1/4 (6.35)	3/8 (9.52)	3/8 (9.52)	3/8 (9.52)	3/8 (9.52)
	Gas (Flare)		1/2 (12.70)	5/8 (15.88)	5/8 (15.88)	5/8 (15.88)	5/8 (15.88)
Condensate Drain hose diameter (I.D./O.D.)		in.	3/4 / 1-1/16			3/4 / 1-1/16	
Cassette Grille	Model name		UTG-LCGVCW / UTG-LCGVCB			UTG-LCGVCW / UTG-LCGVCB	
	Dimensions (H×W×D)		2-1/16 x 37-3/8 x 37-3/8 (53 x 950 x 950)			2-1/16 x 37-3/8 x 37-3/8 (53 x 950 x 950)	
	Weight		13.0 (6.0)			13.0 (6.0)	

Note : Specifications are based on the following conditions: Built-in protective functions may limit capacity or shut off unit if unit is operated outside of unit design operating temperature ranges. Cooling : Indoor temperature of 80°F(26.7°C)DB/67°F(19.4°C)WB; and outdoor temperature of 95°F(35°C)DB/75°F(23.9°C)WB. Heating : Indoor temperature of 70°F(21.1°C)DB/60°F(15.6°C)WB, and outdoor temperature of 47°F(8.3°C)DB/43°F(6.1°C)WB. Pipe Length : 25ft. (7.5m), Height difference : 0ft.(0m) (Outdoor unit - indoor unit).

Individual louver control

Individually controlled louvers for comfortable air distribution in any room configuration. Compatible remotes and central controllers are: Touch Panel Wired RC (UTY-RNRUZ*) / Touch Panel Controller (UTY-DTGYZ1), System Controller (UTY-APGXZ1) / System Controller Lite (UTY-ALGXZ1).

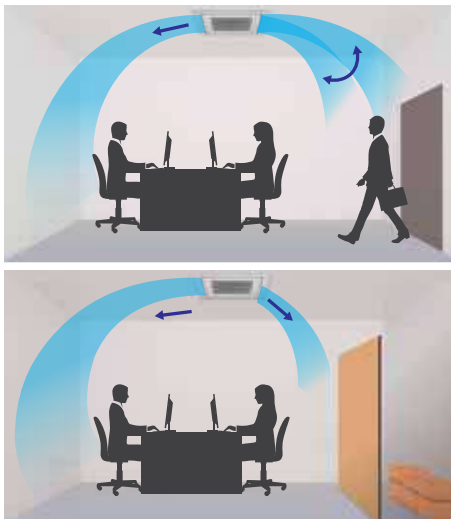

Louvers adjust air flow direction for constant comfort for people in the room.

Occupancy/human sensor setting (optional)

Saves energy by automatically turning off the unit if the room is unoccupied.

2 modes can be selected.

Auto saving

Power is saved while no one is around

Auto OFF

Operation is stopped while no one is around

Human Sensor feature is available through Wired Remote Control (Touch Panel) UTY-RNRUZ.



Quiet operation with 6 fan speed control

With 6 fan speeds to choose from, circular flow cassette models operate at whisper quiet sound levels.

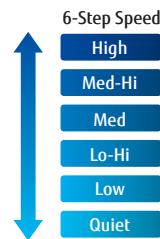

* Compatible Remote Controller is as follows:
UTY-RNRUZ2 / UTY-RSRY / UTY-RHRY / UTY-DCGY / UTY-DTGYZ1 / UTY-ALGXZ1 / UTY-APGXZ1

Optional parts

Wired Remote Control (Touch Panel) UTY-RNRUZ*
Wireless Remote Control..... UTY-LNHU
Simple Remote Control..... UTY-RSRY, UTY-RHRY
IR Receiver Unit..... UTY-LBHXD
Human Sensor Kit UTY-SHZXC

Air Outlet Shutter Plate UTR-YDZK
Wide Panel UTG-AKXA-W
Panel Spacer UTG-BKXA-W
Insulation Kit For High Humidity..... UTZ-KXRA

Dimensions

(Unit: In (mm))

Models:

AUUB18TLAV1 / AUUB24TLAV1 / AUUB30TLAV1

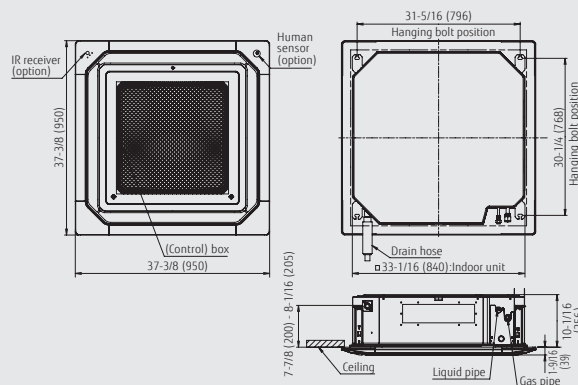

AUUB36TLAV1 / AUUB48TLAV1

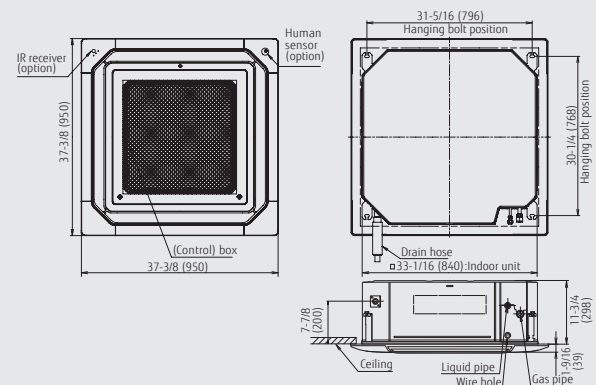

Large 4-Way Cassette

AUUB18RLAV / TLAV

AUUB24RLAV

AUUB30RLAV



Powerful, wide airflow and quiet operation.

Cassette Grille UTG-LCGV sold separately.

High efficiency turbo fan with 3-dimensional blade

3-dimensional fan blade design for efficient air distribution across the heat exchanger.

Quiet

Optimized fan design for quiet and efficient operation

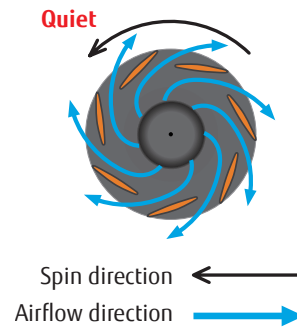
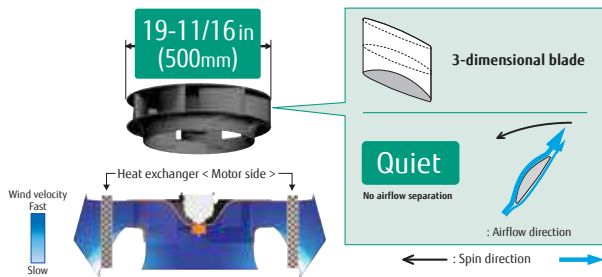

Specifications

Model name		AUUB18RLAV / TLAV		AUUB24RLAV		AUUB30RLAV		
Power source		1 Phase ~ 208/230V 60Hz						
Capacity	Cooling	BTUh	18,000	24,000	30,000			
		kW	5.3	7.0	8.8			
	Heating	BTUh	20,000	27,000	34,000			
		kW	5.9	7.9	10.0			
Input power		W	39	46	59			
Airflow rate	High	CFM (m ³ /h)	677 (1,150)	753 (1,280)	942 (1,600)			
	Med		553 (940)	612 (1,040)	765 (1,300)			
	Low		512 (870)	512 (870)	647 (1,100)			
Sound pressure level	High	dB (A)	36	38	40			
	Med		30	33	38			
	Low		29	29	33			
Dimensions (H × W × D)		in.(mm)	9-11/16 × 33-1/16 × 33-1/16 (246 × 840 × 840)			11-5/16 × 33-1/16 × 33-1/16 (288 × 840 × 840)		
Weight		lbs.(kg)	49 (22)	49 (22)	60 (27)			
Connection pipe diameter	Liquid (Flare)		3/8 (9.52)	3/8 (9.52)	3/8 (9.52)			
	Gas (Flare)	in.(mm)	5/8 (15.88)	5/8 (15.88)	5/8 (15.88)			
Drain hose diameter (I.D./O.U.)			3/4 / 1-1/16					
Cassette Grille	Model name		UTG-LCGV					
	Dimensions (H×W×D)	in.(mm)	1-15/16 × 37-3/8 × 37-3/8 (50 × 950 × 950)					
	Weight	lbs.(kg)	13 (5.5)					

Note : Specifications are based on the following conditions.

Cooling : Indoor temperature of 80°F(26.7°C)DB/67°F(19.4°C)WB,and outdoor temperature of 95.0°F(35°C)DB/75°F(23.9°C)WB.

Heating : Indoor temperature of 70°F(21.1°C)DB/60°F(15.6°C)WB,and outdoor temperature of 47°F(8.3°C)DB/43°F(6.1°C)WB.

Pipe length : 25ft.(7.5 m), Height difference : 0ft.(0 m) (Outdoor unit - Indoor unit).

Built-in protective functions may limit capacity or shut off unit if unit is operated outside of unit design operating temperature ranges.

Optimized airflow distribution

Motorized louvers designed for optimized air distribution.

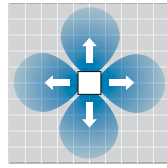
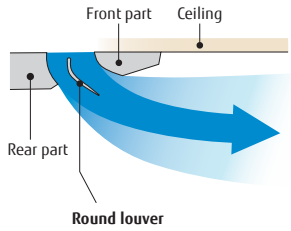

Bottom view



Wide air exhaust for even temperature distribution.

High lift pump

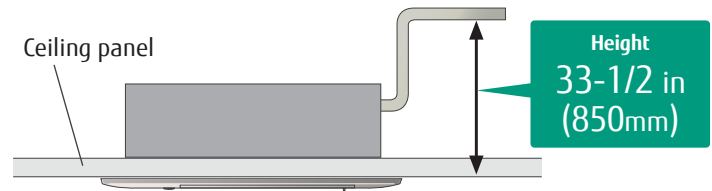

Built-in condensate drain pump

Adjustable hanger position



High ceiling mode

Can be installed up to a height of 13-3/4ft. (4.2m) (AUUA36).

Model code	The maximum height from floor to ceiling ft. (m)	
	Standard mode	High ceiling mode
18	9' 10-1/8" (3.0)	11' 6" (3.5)
24	9' 10-1/8" (3.0)	11' 6" (3.5)
30	10' 6" (3.2)	11' 9-3/4" (3.6)
36	10' 6" (3.2)	13' 9-3/8" (4.2)

Optional parts

IR Receiver KitUTY-LRHYB1
 Air Outlet Shutter PlateUTR-YDZC
 Panel SpacerUTG-BGYA-W

Insulation Kit for High HumidityUTZ-KXGA / UTZ-KXGB
 Wide PanelUTG-AGYA-W
 Fresh Air Intake KitUTZ-VXGA

Dimensions

(Unit: In (mm))

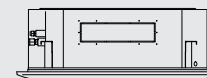
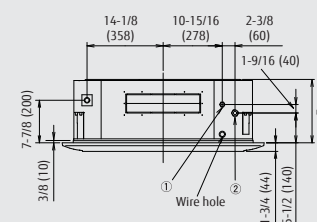
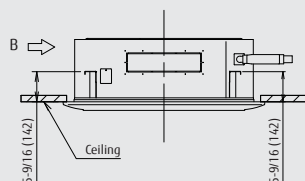
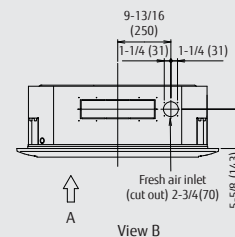
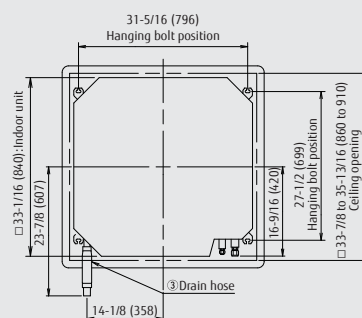
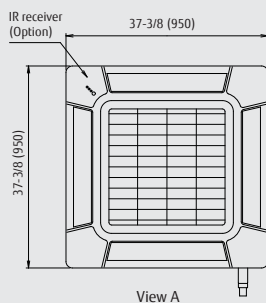

	AUUB 18/24	AUUB 30	AUUB 36
① Refrigerant pipe flare connection (Liquid)	ø 3/8 (9.52)	ø 3/8 (9.52)	ø 3/8 (9.52)
② Refrigerant pipe flare connection (Gas)	ø 5/8 (15.88)	ø 5/8 (15.88)	ø 3/4 (19.05)
③ Drain hose connection (Drain Hose)	ø 3/4 (I.D.), ø 1-1/16 (O.D.)		
④	10-1/16 (256)	11-3/4 (298)	11-3/4 (298)

Slim Compact Duct

- ARUL4TLAV1 / TLAV2 MINI
- ARUL7RLAV / TLAV2 SLIM
- ARUL9RLAV / TLAV / TLAV2 SLIM
- ARUL12RLAV / TLAV2 SLIM
- ARUL14RLAV / TLAV / TLAV2 SLIM
- ARUL18TLAV2 SLIM



ARUL4TLAV1



ARUL7, 9, 12, 14TLAV



ARUL18TLAV



Shown with optional Auto Louver Grille Kit (UTD-GXTA-W, UTD-GXSA-W, UTD-GXSB-W)

Slim design, wide range of static pressure settings and flexible installation orientation.

Slim design

Slim and compact design for flexibility to be installed in narrow spaces.

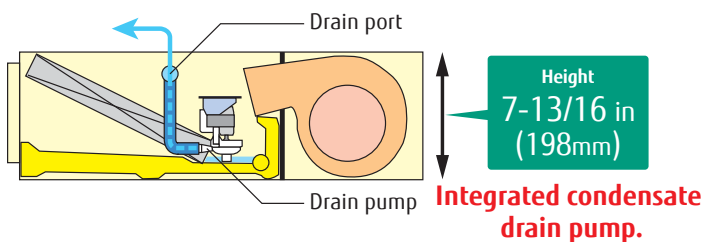

Flexible installation

Can be mounted horizontally or vertically and deliver up to 0.36 in. WG static pressure for flexibility to fit many different application needs. Note: mini duct is horizontal installation only.

Ceiling concealed

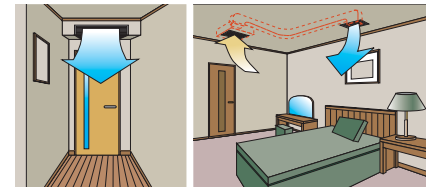

Floor concealed

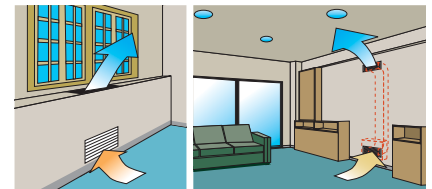

Specifications

Model name			ARUL4TLAV1 / TLAV2	ARUL7RLAV / TLAV2	ARUL9RLAV / TLAV / TLAV2	ARUL12RLAV / TLAV2	ARUL14RLAV / TLAV / TLAV2	ARUL18TLAV2
Power source			1 Phase - 208/230V 60Hz					
Capacity	Cooling	BTUh	4,000	7,500	9,500	12,000	14,000	18,000
		kW	1.2	2.2	2.8	3.5	4.1	5.3
	Heating	BTUh	4,400	9,500	10,900	13,500	15,600	20,000
		kW	1.3	2.8	3.2	4.0	4.6	5.9
Input power		W	26	44	50	54	92	83
Airflow rate	High	CFM (m ³ /h)	271 (460)	324 (550)	353 (600)	353 (600)	471 (800)	553 (940)
	Med		247 (420)	288 (490)	324 (550)	300 (510)	418 (710)	494 (840)
	Low		218 (370)	258 (440)	283 (480)	265 (450)	359 (610)	441 (750)
Static pressure range		in.WG	0 to 0.12 (0 to 30)	0 to 0.36 (0 to 90)	0 to 0.36 (0 to 90)	0 to 0.36 (0 to 90)	0 to 0.36 (0 to 90)	0 to 0.36 (0 to 90)
Standard static pressure		(Pa)	0.04 (10)	0.10 (25)	0.10 (25)	0.10 (25)	0.10 (25)	0.10 (25)
Sound pressure level	High	dB (A)	25	28	29	30	34	34
	Med		23	25	26	27	32	32
	Low		21	22	24	24	28	28
Dimensions (H x W x D)		in.(mm)	7-13/16 x 27-9/16 x 17-11/16 (198 x 700 x 450)	7-13/16 x 27-9/16 x 24-7/16 (198 x 700 x 620)				7-13/16 x 35-7/16 x 24-7/16 (198 x 900 x 620)
Weight		lbs.(kg)	32 (14.5)	37 (17)	37 (17)	40 (18)	40 (18)	49 (22)
Connection pipe diameter	Liquid (Flare)		1/4 (6.35)	1/4 (6.35)	1/4 (6.35)	1/4 (6.35)	1/4 (6.35)	3/8 (9.52)
	Gas (Flare)	in.(mm)	3/8 (9.52)	1/2 (12.70)	1/2 (12.70)	1/2 (12.70)	1/2 (12.70)	5/8 (15.88)
Drain hose diameter (I.D./O.U.)			3/4 / 1-1/16					

Note : Specifications are based on the following conditions.

Cooling : Indoor temperature of 80°F(26.7°C)DB/67°F(19.4°C)WB,and outdoor temperature of 95.0°F(35°C)DB/75°F(23.9°C)WB.

Heating : Indoor temperature of 70°F(21.1°C)DB/60°F(15.6°C)WB,and outdoor temperature of 47°F(8.3°C)DB/43°F(6.1°C)WB.

Pipe length : 25ft.(7.5 m), Height difference : 0ft.(0 m) (Outdoor unit - Indoor unit).

Built-in protective functions may limit capacity or shut off unit if unit is operated outside of unit design operating temperature ranges.

Condensate drain pump (Standard)

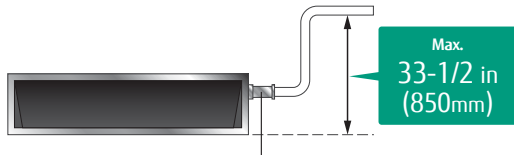

Filter (Included)

ARUL7 / 9 / 12 / 14 / 18
Minimum Height Requirement 9-3/4"

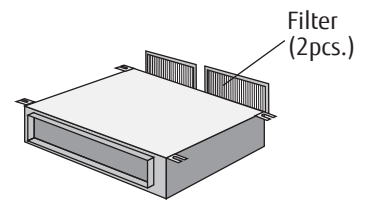

Selectable external static pressure

External static pressure can be selected from 0 up to 0.36 in. WG with remote controller.



Static pressure range
0.1 to 0.36 in.WG
(0 to 90Pa)

Auto Louver Grille Kit (Option)

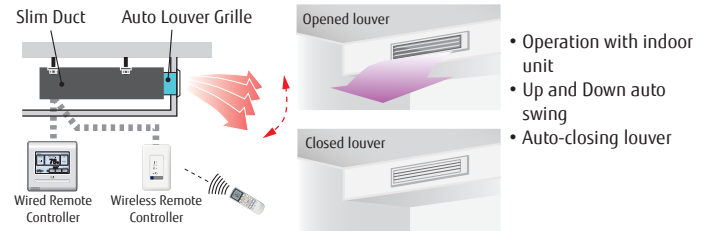

Air inlet

Flexible with alternative air inlets to fit any layout.

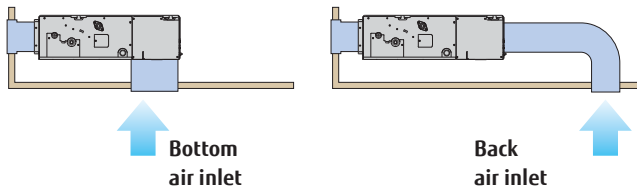

Optional parts

- Auto Louver Grille Kit..... UTD-GXTA-W (for ARUL4TLAV1)
UTD-GXSA-W (for ARUL7/9/12/14TLAV)
UTD-GXSB-W (for ARUL18TLAV)
- IR Receiver Unit..... UTB-YWC
- Remote Sensor Unit..... UTY-XSZX

Dimensions

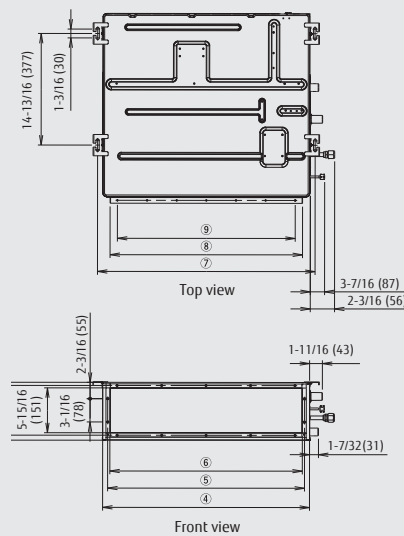

(Unit: In (mm))

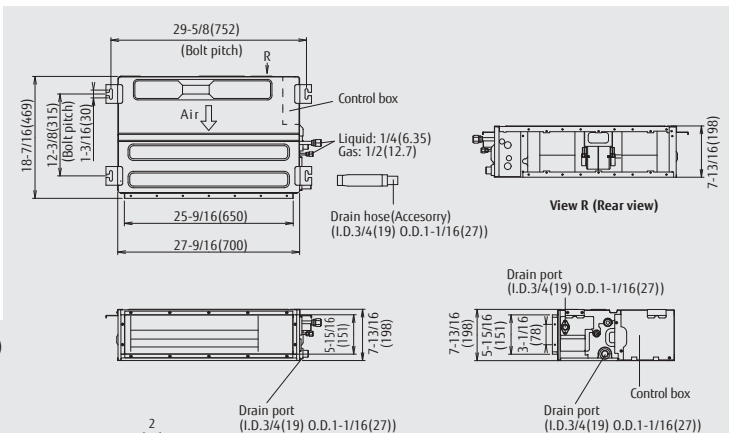
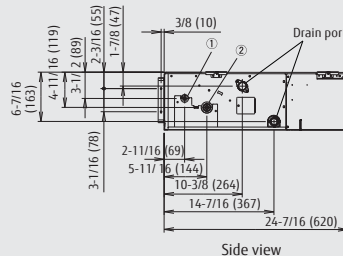
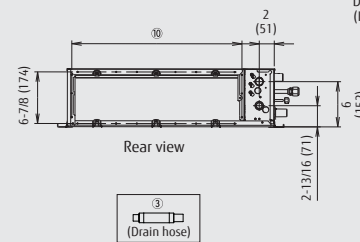

	ARUL 7/9/12/14	ARUL 18
① Refrigerant pipe flare connection (Liquid)	ø 1/4 (6.35)	ø 3/8 (9.52)
② Refrigerant pipe flare connection (Gas)	ø 1/2 (12.70)	ø 5/8 (15.88)
③ Drain hose connection (Drain Hose)	ø 3/4 (I.D.), ø 1-1/16 (O.D.)	
④	27-9/16 (700)	35-7/16 (900)
⑤	26-1/8 (664)	34 (864)
⑥	25-9/16 (650)	33-7/16 (850)
⑦	28-7/8 (734)	36-3/4 (934)
⑧	25-9/16 (650)	33-7/16 (850)
⑨	3-15/16 (100) x 6 = 23-5/8 (600) 3-15/16 (100) x 8 = 31-1/2 (800)	
⑩	22-5/8 (574)	30-1/2 (774)

Medium Static Pressure Duct

ARUM24TLAV2

ARUM30RLAV / TLAV / TLAV2

ARUM36RLAV / TLAV / TLAV2



Slim & Compact design

Compact, slim height, and integrated control box makes the indoor unit suitable for applications where the height is limited.

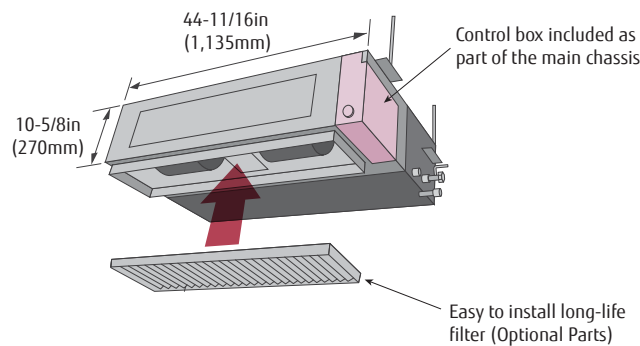

Easy maintenance

Maintenance friendly design with easy access to motor and fan by quickly removing two bottom panels on the indoor unit.

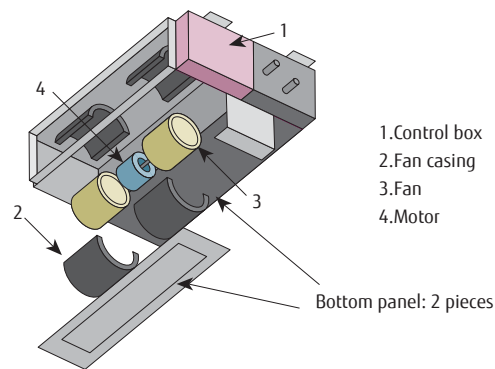

Specifications

Model name			ARUM24TLAV2	ARUM30RLAV / TLAV / TLAV2	ARUM36RLAV / TLAV / TLAV2
Power source			1 Phase - 208/230V 60Hz		
Capacity	Cooling	BTUh	24,000	30,000	36,000
		kW	7.0	8.8	10.6
	Heating	BTUh	27,000	34,000	40,000
		kW	7.9	10.0	11.7
Input power			W	125	190
Airflow rate	High	CFM (m ³ /h)	859 (1,460)	1,042 (1,770)	1,112 (1,890)
	Med		724 (1,230)	812 (1,380)	895 (1,520)
	Low		589 (1,000)	589 (1,000)	677 (1,150)
Static pressure range			in.WG	0 to 0.60 (0 to 150)	0 to 0.60 (0 to 150)
Standard static pressure			(Pa)	0.16 (40)	0.16 (40)
Sound pressure level	High	dB (A)	36	40	41
	Med		31	33	35
	Low		28	28	29
Dimensions (H × W × D)			in. (mm)	10-5/16 × 44-11/16 × 27-9/16 (270 × 1,135 × 700)	
Weight			lbs. (kg)	86 (39)	86 (39)
Connection pipe diameter	Liquid (Flare)	in. (mm)	3/8 (9.52)	3/8 (9.52)	3/8 (9.52)
	Gas (Flare)		5/8 (15.88)	5/8 (15.88)	3/4 (19.05)
Condensate Drain hose diameter (I.D./O.U.)			3/4" / 1-1/16"		

Note : Specifications are based on the following conditions.

Cooling : Indoor temperature of 80°F(26.7°C)DB/67°F(19.4°C)WB,and outdoor temperature of 95.0°F(35°C)DB/75°F(23.9°C)WB.

Heating : Indoor temperature of 70°F(21.1°C)DB/60°F(15.6°C)WB,and outdoor temperature of 47°F(8.3°C)DB/43°F(6.1°C)WB.

Pipe length : 25ft. (7.5 m), Height difference : 0ft. (0 m) (Outdoor unit - Indoor unit).

Built-in protective functions may limit capacity or shut off unit if unit is operated outside of unit design operating temperature ranges.

Two-direction condensate drain piping

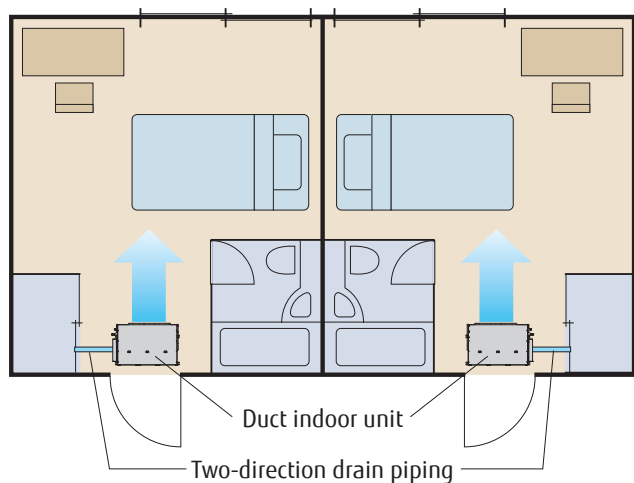

Installation styles

Embedded in Ceiling

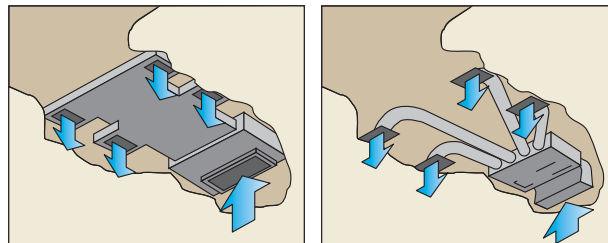

Hanging from Ceiling

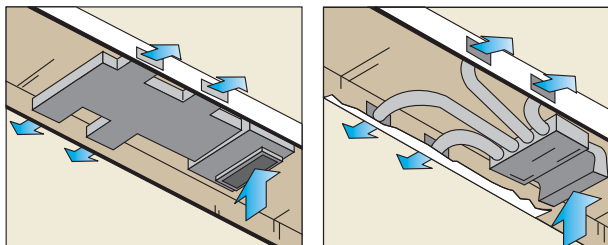

High efficiency DC fan motors

24 model



30/36 model



Optional parts

Drain Pump Unit.....	UTZ-PU1NBA
Long Life Filter*	UTD-LF25NA
Flange (Square)	UTD-SF045T
Flange (Round)	UTD-RF204
IR Receiver Unit.....	UTB-YWC
Remote Sensor Unit.....	UTY-XSZX

*Note, Medium Static Pressure Duct models do not include a standard filter.

Dimensions

(Unit: In (mm))

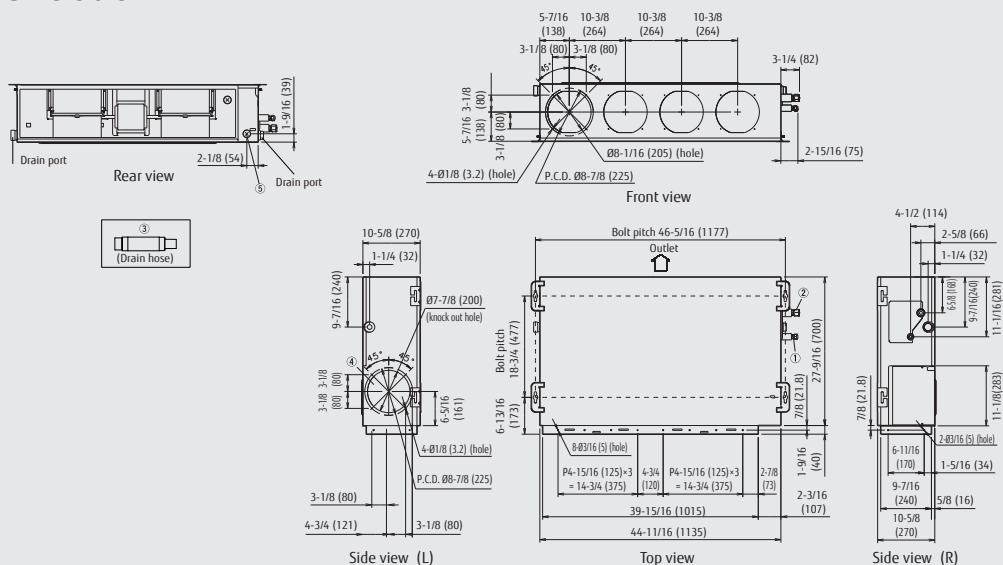

	ARUM 24/30	ARUM 36
① Refrigerant pipe flare connection (Liquid)	ø 3/8 (9.52)	ø 3/8 (9.52)
② Refrigerant pipe flare connection (Gas)	ø 5/8 (15.88)	ø 3/4 (19.05)
③ Drain hose connection (Drain Hose)	ø 3/4 (I.D.), ø 1-1/16 (O.D.)	
④ Knock out hole (fresh air)	7-7/8 (200)	7-7/8 (200)
⑤ Hole for power cable	7/8 (23)	7/8 (23)

High Static Pressure Duct (3, 4, 5 ton)

- ARUH36TLAV
- ARUH48TLAV
- ARUH60TLAV

High Static Pressure Ducted Indoor units with powerful capabilities of up to 1 in. WG external static pressure. Improved ductwork and filtration flexibility with high CFM and ESP capabilities.



Compact size for flexible installation

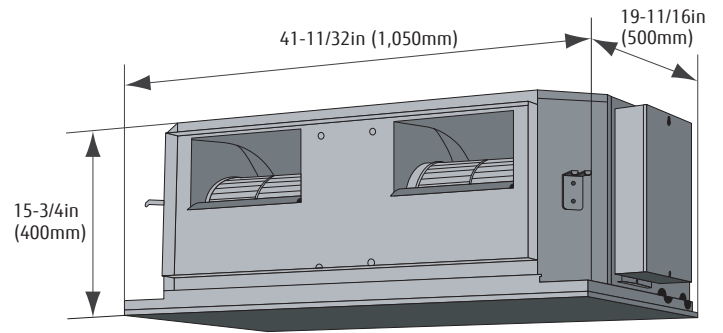

Specifications

Model name			ARUH36TLAV	ARUH48TLAV	ARUH60TLAV
Power source			1 Phase - 208/230V 60Hz		
Capacity	Cooling	BTUh	36,000	48,000	60,000
		kW	10.6	14.1	17.6
	Heating	BTUh	40,000	54,000	67,000
		kW	11.7	15.8	19.6
Input power		W	496	752	806
Airflow rate	High	CFM (m ³ /h)	1,324 (2,250)	1,766 (3,000)	1,972 (3,350)
	Med		1,030 (1,750)	1,589 (2,700)	1,678 (2,850)
	Low		824 (1,400)	1,354 (2,300)	1,501 (2,550)
Static pressure range		in.WG	0.40 to 0.80 (100 to 200)	0.40 to 1.00 (100 to 250)	0.40 to 1.00 (100 to 250)
Standard static pressure		(Pa)	0.40 (100)	0.40 (100)	0.40 (100)
Sound pressure level	High	dB (A)	43	47	48
	Med		37	43	44
	Low		32	40	41
Dimensions (H × W × D)		in.(mm)	15-3/4 × 41-5/16 × 19-11/16 (400 × 1,050 × 500)		
Weight		lbs.(kg)	97 (44)	101 (46)	101 (46)
Connection pipe diameter	Liquid (Flare)	in.(mm)	3/8 (9.52)	3/8 (9.52)	3/8 (9.52)
	Gas (Flare)		3/4 (19.05)	3/4 (19.05)	3/4 (19.05)
Condensate Drain hose diameter (I.D./O.U.)			3/4" / 1-1/16"		

Note : Specifications are based on the following conditions.

Cooling : Indoor temperature of 80°F(26.7°C)DB/67°F(19.4°C)WB, and outdoor temperature of 95.0°F(35°C)DB/75°F(23.9°C)WB.

Heating : Indoor temperature of 70°F(21.1°C)DB/60°F(15.6°C)WB, and outdoor temperature of 47°F(8.3°C)DB/43°F(6.1°C)WB.

Pipe length : 25ft. (7.5 m), Height difference : 0ft. (0 m) (Outdoor unit - Indoor unit).

Built-in protective functions may limit capacity or shut off unit if unit is operated outside of unit design operating temperature ranges.

High static pressure design

Up To
1 in.WG
(250Pa)
(ARUH48/60)

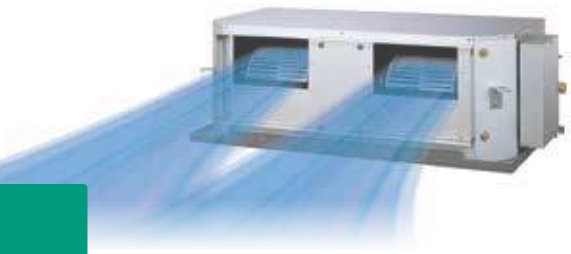

QUIET OPERATION

Indoor unit

Optimized unit chassis design reduces internal air turbulence and lowers the sound levels.

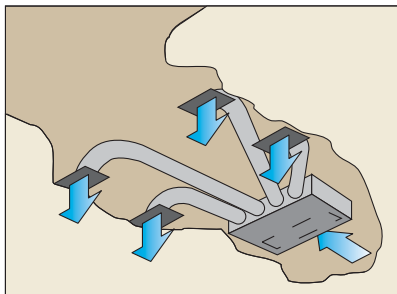
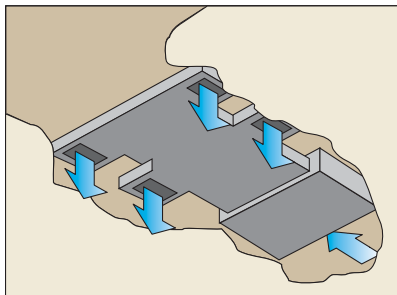
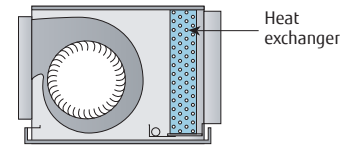
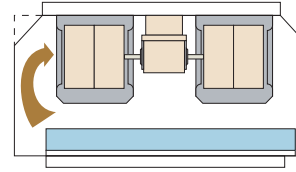

Optional parts

Long-Life Filter* UTD-LF60KA
 IR Receiver Unit UTB-YWC
 Remote Sensor Unit UTY-XSZX
 *Note, High Static Pressure Duct models do not include a standard filter.

Dimensions

(Unit: In (mm))

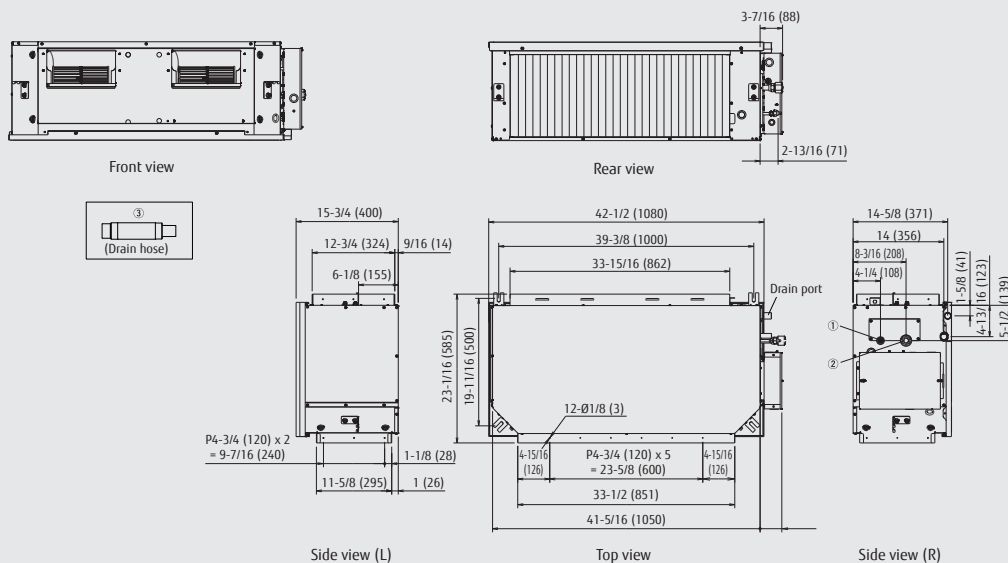

	ARUH 36/48/60
① Refrigerant pipe flare connection (Liquid)	ø 3/8 (9.52)
② Refrigerant pipe flare connection (Gas)	ø 3/4 (19.05)
③ Drain hose connection (Drain Hose)	ø 3/4 (I.D.), ø 1-1/16 (O.D.)

Economizer and filter box options are available through affiliated third party. Ask your local Fujitsu Airstage distributor for details.

High Static Pressure Duct (6, 8 ton)

ARUH72TLAV2

ARUH96TLAV2

High capacity and High Static Pressure Ducted Indoor units with powerful capabilities of up to 1.2in. WG external static pressure. Improved ductwork and filtration flexibility with high CFM and ESP capabilities.



Outdoor unit : AOUA72RLAV
Indoor unit : ARUH72TLAV1

Outdoor unit : AOUA96RLAV
Indoor unit : ARUH96TLAV

Specifications

Model name			ARUH72TLAV2	ARUH96TLAV2
Power source			1 Phase - 208/230V 60Hz	
Capacity	Cooling	BTUh	72,000	96,000
		kW	21.1	28.1
	Heating	BTUh	81,000	108,000
		kW	23.7	31.7
Input power		W	618	838
Airflow rate	High	CFM (m ³ /h)	2296 (3900)	2855 (4850)
	Med		1942 (3300)	2502 (4250)
	Low		1766 (3000)	2119 (3600)
Static pressure range		in.WG	0 to 1.2 (0 to 300)	0 to 1.2 (0 to 300)
Standard static pressure		(Pa)	0.6 (150)	0.6 (150)
Sound pressure level	High	dB (A)	47	48
	Med		43	45
	Low		40	42
Dimensions (H x W x D)		in.(mm)	17-11/16 x 62-1/2 x 27-9/16 (450 x 1587 x 700)	21-5/8 x 62-1/2 x 27-9/16 (550 x 1587 x 700)
Weight		lbs.(kg)	203 (92)	231 (105)
Connection pipe diameter	Liquid (Flare)	in.(mm)	1/2 (12.70)	1/2 (12.70)
	Gas (Flare)		7/8 (22.22)	7/8 (22.22)
Condensate Drain hose diameter (I.D./O.U.)			3/4" / 1-1/16"	

Multi-Position Air Handling Unit

ARUX12TLAV2
 ARUX18TLAV2
 ARUX24TLAV2
 ARUX30TLAV2

ARUX36TLAV2
 ARUX48TLAV2
 ARUX60TLAV2

Static Pressure Range
0.1 to 0.8 in.W.G
 (25 to 200Pa)



ARUX12TLAV2
 ARUX18TLAV2
 ARUX24TLAV2



ARUX30TLAV2
 ARUX36TLAV2



ARUX48TLAV2
 ARUX60TLAV2

Flexible Installation and Wide Static Pressure Range

Flexible and compact design to suit most light commercial and residential applications. At 43" tall and only 17-1/2" wide for up to 2 tons, the unit can be installed in tight closet spaces.

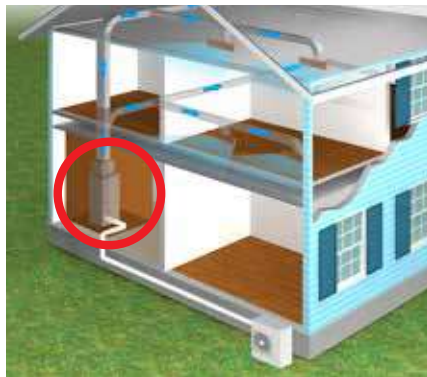

UP FLOW
 Installed in basement or in a narrow closet, distributing conditioned air to the rooms.

Optimum Temperature Control Using Backup Heater (Optional)

Control operation of auxiliary heaters depending on the difference between room temperature and set temperature to maintain optimum comfort.



HORIZONTAL LEFT / RIGHT AIRFLOW
 Installed horizontally in the attic, with overhead distribution of conditioned air to the rooms.

Dimensions

(Unit: In (mm))

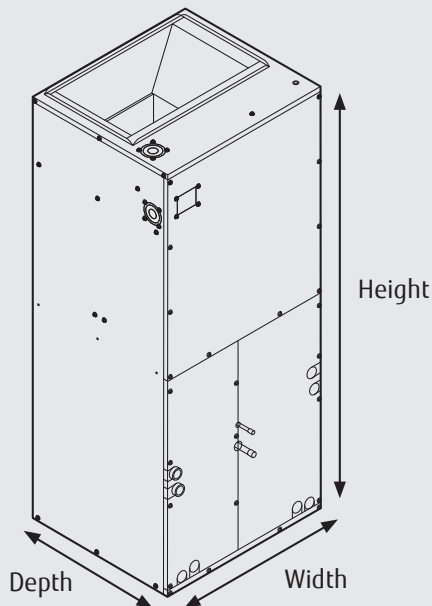

	ARUX12-18-24TLAV2	ARUX30-36TLAV2	ARUX48-60TLAV2
Height	43 in. (1,092 mm)	48 in. (1,219 mm)	58.75 in. (1,492 mm)
Width	17.5 in. (444 mm)	21 in. (533 mm)	24.5 in. (622 mm)
Depth	21 in. (533 mm)	21 in. (533 mm)	21.75 in. (553 mm)

Options

Compatible with a variety of controller options, such as individual controller, central controller and building management controller.

Wireless Remote Controller / IR Receiver	UTY-LNHU / UTY-TRHX	BACnet® Gateway	UTY-VBGX (Hardware)
Wired Remote Controller	UTY-RNRUZ5		UTY-ABGXZ1 (Software)
Simple Remote Controller	UTY-RHRY	External Power Supply Unit	UTZ-GXXA
External Switch Controller	UTY-TERX	Thermostat Converter	UTY-TTRX
Central Remote Controller	UTY-DCGYZ2	Network Converter	UTY-VTGX (DC power supply)
Touch Panel Controller	UTY-DTGYZ1		UTY-VGGXZ1 (AC power supply)
Wireless LAN Adapter	UTY-TFSXZ2	Highrise 360 Kit	UTY-SPWX
System Controller	UTY-APGXZ1	Network Converter for LONWORKS®	UTY-VLGX
System Controller Lite	UTY-ALGXZ1	Signal Amplifier	UTY-VSGXZ1
Service Tool	UTY-ASGXZ1	External Connect Kit	UTY-XWZXZB / UTY-XWZXZD
Web Monitoring Tool	UTY-AMGXZ1		UTY-XWZXZ7 / UTY-XWZXZE
Remote Sensor Unit	UTY-XSZX		UTY-XWZXZC / UTY-XWZXZK
MODBUS Converter	UTY-VMSX / UTY-VMGX		

Specifications

Model name			ARUX12TLAV2	ARUX18TLAV2	ARUX24TLAV2	ARUX30TLAV2	ARUX36TLAV2	ARUX48TLAV2	ARUX60TLAV2		
Power supply			1 phase ~ 208/230 V 60 Hz								
Available voltage range			187-253 V								
Capacity	Cooling	Btu/h	12,000	18,000	24,000	30,000	36,000	48,000	60,000		
		kW	3.5	5.3	7.0	8.8	10.6	14.1	17.6		
	Heating	Btu/h	13,500	20,000	27,000	34,000	40,000	54,000	67,000		
		kW	4.0	5.9	7.9	10.0	11.7	15.8	19.6		
Input power			W	77	99	148	180	241	322	521	
Static pressure range			inWG (Pa)	0.10 to 0.80 (25 to 200)							
Standard static pressure			inWG (Pa)	0.50 (125)							
Fan	Airflow rate	HIGH	CFM (m3/h)	350 (595)	500 (850)	650 (1,104)	880 (1,495)	1,050 (1,784)	1,400 (2,379)	1,700 (2,888)	
		MED	320 (544)	450 (765)	590 (1,002)	800 (1,359)	950 (1,614)	1,260 (2,141)	1,550 (2,633)		
		LOW	290 (493)	400 (680)	510 (866)	730 (1,240)	850 (1,444)	1,130 (1,920)	1,340 (2,277)		
	Type × Q'ty	Sirocco × 1									
Motor output			W	249			373		560		
Sound pressure level*		HIGH	dB (A)	37	38	40	42	44	46	48	
		MED		35	36	37	40	42	44	46	
		LOW		33	34	34	38	40	42	42	
Heat exchanger type	Length	in (mm)	16 (406)	16 (406)	16 (406)	16 (406)	16 (406)	17-1/2 (446)	17-1/2 (446)		
	Fin pitch	FPI	16	16	16	14	14	14	14		
	Rows × Stages		4 × 14	2 × 18	2 × 18	3 × 22	3 × 22	3 × 30	4 × 30		
	Face area	ft2 (m2)	2.6 (0.24)	3.3(0.31)	3.3(0.31)	4.0 (0.38)	4.0 (0.38)	6.0 (0.56)	6.0 (0.56)		
	Pipe type (Material)	Grooved H-pin (Copper)									
	Fin	Type (Material)	Louver (Aluminum)								
		Surface treatment	Louver (Aluminum)								
Enclosure	Material	Painted galvanized steel sheet									
	Color	Gray									
Dimensions (H × W × D)	Net	in (mm)	43 × 17-1/2 × 21 (1,092 × 444 × 533)			48 × 21 × 21 (1,219 × 533 × 533)		58-3/4 × 24-1/2 × 21-3/4 (1,492 × 622 × 552)			
	Gross		45 × 19-3/4 × 26-3/4 (1,143 × 502 × 679)			52 × 23 × 26-3/4 (1,321 × 584 × 679)		63 × 27 × 27-1/2 (1600 × 686 × 699)			
Weight	Net	lb (kg)	100 (45.4)	102 (46.3)	102 (46.3)	126 (57.2)	126 (57.2)	172 (78.0)	181 (82.1)		
	Gross		111 (50.3)	113 (51.3)	113 (51.3)	139 (63.0)	139 (63.0)	187 (84.8)	196 (88.9)		
Connection pipe diameter	Liquid	in (mm)	Ø 1/4 (6.35)	Ø 1/4 (6.35)	Ø 1/4 (6.35)	Ø 3/8 (9.52)	Ø 3/8 (9.52)	Ø 3/8 (9.52)	Ø 3/8 (9.52)		
	Gas		Ø 1/2 (12.70)	Ø 1/2 (12.70)	Ø 1/2 (12.70)	Ø 5/8 (15.88)	Ø 5/8 (15.88)	Ø 5/8 (15.88)	Ø 5/8 (15.88)		
	Connection method	Brazing									
Drain hose		in (mm)	I.D.: Ø 3/4 (19.05)								

NOTES:

Specifications are based on the following conditions:

- Cooling: Indoor temperature of 80 °FDB/67 °FWB (26.7 °CDB/19.4 °CWB), and outdoor temperature of 95 °FDB/75 °FWB (35 °CDB/23.9 °CWB).
- Heating: Indoor temperature of 70 °FDB/60 °FWB (21.1 °CDB/15.6 °CWB), and outdoor temperature of 47 °FDB/43 °FWB (8.3 °CDB/6.1 °CWB).
- Pipe length: 25 ft (7.5 m), Height difference: 0 ft (0 m). (Between outdoor unit and indoor unit.)

Protective function might work when using it outside the operation range.

*: Sound pressure level:

- Measured values in manufacturer's anechoic chamber.
- Because of the surrounding sound environment, the sound levels measured in actual installation conditions might be higher than the specified values here.

Actual product color may be different from the colors shown here. Specifications and design are subject to change without notice.

“AIRSTAGE” is a worldwide trademark of FUJITSU GENERAL LIMITED and is a registered trademark in Japan and other countries or areas.

Floor Mount

AGUA4TLAV2

AGUA7TLAV2

AGUA9TLAV2

AGUA12TLAV2

AGUA14TLAV2



Dual Fans and Wide Airflow

Individual vertical airflow by 2 fans for optimized air distribution and comfort in the entire room.

Cooling

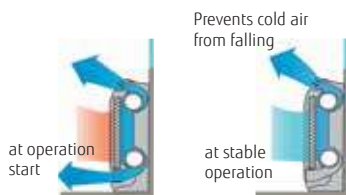

Heating

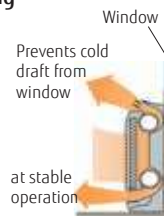

Flexible Piping Connection

Flexible installation with 6 positions for condensate drain hose and piping to choose from: right, left, side and down positions.

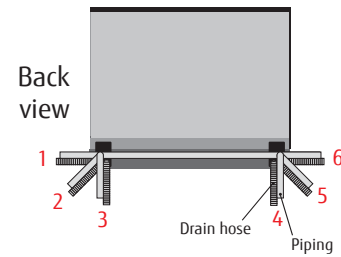

Specifications

Model name			AGUA4TLAV2	AGUA7TLAV2	AGUA9TLAV2	AGUA12TLAV2	AGUA14TLAV2
Power Source			1 Phase - 208 / 230V ~ 60Hz				
Capacity	Cooling	BTUh	4,000	7,500	9,500	12,000	14,000
		kW	1.2	2.2	2.8	3.5	4.1
	Heating	BTU/h	4,400	9,500	10,900	13,500	15,600
		kW	1.3	2.8	3.2	4.0	4.6
Input Power		W	12 / 14	16	17	22	29
Max. Operating Current		A	0.19 / 0.22	0.24	0.25	0.30	0.38
Airflow rate	High	CFM (m ³ /h)	224 (380) / 253 (430)*	277 (470)	294 (500)	347 (590)	394 (670)
	Med-Hi		206 (350)	247 (420)	265 (450)	306 (520)	347 (590)
	Med		188 (320)	230 (390)	235 (400)	277 (470)	306 (520)
	Lo-Hi		182 (310)	212 (360)	212 (360)	247 (420)	265 (450)
	Low		165 (280)	194 (330)	194 (330)	230 (390)	230 (390)
	Quiet		124 (210)	159 (270)	159 (270)	200 (340)	200 (340)
Sound pressure level	High	dB(A)	35/36*	37	38	42	46
	Med-Hi		33	35	36	39	42
	Med		31	33	34	37	39
	Lo-Hi		30	31	31	35	36
	Low		28	29	29	33	33
	Quiet		22	22	22	30	30
Dimensions (H x W x D)		in.(mm)	23-5/8 x 29-1/8 x 7-7/8 (600 x 740 x 200)				
Weight		lbs.(kg)	33 (15)	33 (15)	33 (15)	33 (15)	33 (15)
Connection pipe diameter	Liquid (Flare)	in.(mm)	1/4 (6.35)	1/4 (6.35)	1/4 (6.35)	1/4 (6.35)	1/4 (6.35)
	Gas (Flare)		3/8 (9.52)	3/8 (9.52)	3/8 (9.52)	1/2 (12.70)	1/2 (12.70)
Condensate Drain hose diameter (I.D./O.D.)		in.	9/16 / 5/8 to 11/16				

Note: Specifications are based on the following conditions: Built-in protective functions may limit capacity or shut off unit if unit is operated outside of unit design operating temperature ranges. Cooling: Indoor temperature of 80°F(26.7°C)DB/67°F(19.4°C)WB; and outdoor temperature of 95°F(35°C)DB/75°F(23.9°C)WB. Heating: Indoor temperature of 70°F(21.1°C)DB/60°F(15.6°C)WB, and outdoor temperature of 47°F(8.3°C)DB/43°F(6.1°C)WB. Pipe Length : 25ft. (7.5m), Height difference : 0ft.(0m) (Outdoor unit - indoor unit).

*Cooling operation / heating operation.

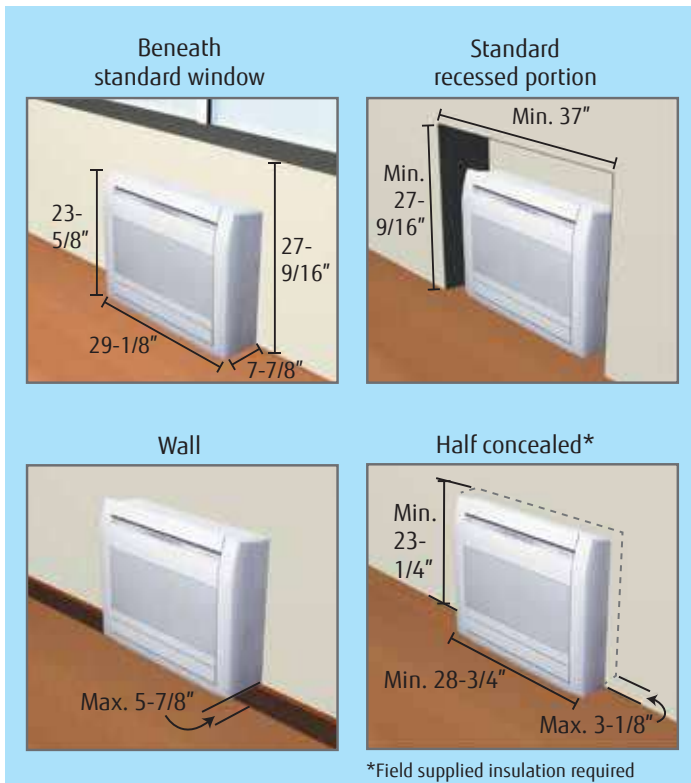

Quiet Operation

With 6 fan speeds to choose from, floor mounted models operate as quietly as 22 dB(A).



6-Step Speed

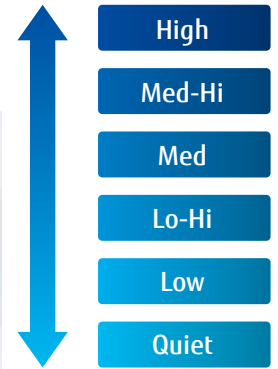

Flexible and Easy Installation

At less than 24" high and 30" wide, floor mount models fit easily under a standard window and can replace a traditional radiator twice its size while producing more capacity.

Optional parts

- Wired Remote Controller UTU-RNRUZ*
- Wireless Remote Controller..... UTU-LNHU
- Simple Remote Controller UTU-RSRY, UTU-RHRY
- Half Concealed Kit UTR-STA

Dimensions

(Unit: In (mm))

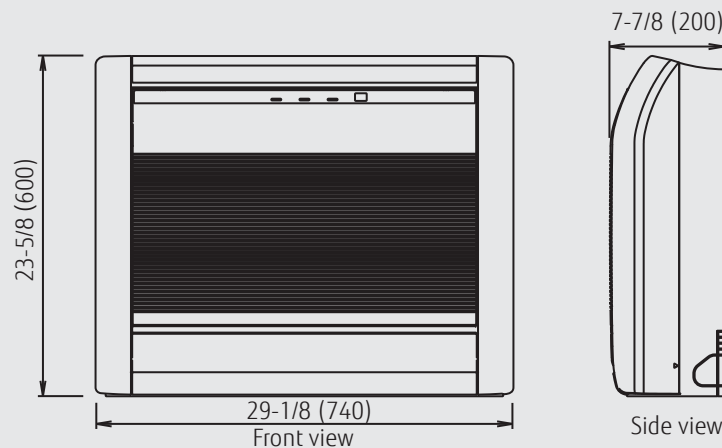

Floor / Ceiling

ABUA12TLAV / TLAV2

ABUA14RLAV / TLAV / TLAV2

ABUA18RLAV / TLAV / TLAV2

ABUA24TLAV / TLAV2



The slim and lightweight design allows the unit to be suspended horizontally from the ceiling or installed vertically on the floor, offering flexibility in design and installation.

Note: IR Receiver is standard for communicating with optional Wireless Remote Control.

Flexible installation

Example of floor installation



Example of ceiling installation



Specifications

Model name			ABUA12TLAV / TLAV2	ABUA14RLAV / TLAV / TLAV2	ABUA18RLAV / TLAV / TLAV2	ABUA24TLAV / TLAV2
Power source			1 Phase ~ 208/230V 60Hz			
Capacity	Cooling	BTUh	12,000	14,000	18,000	24,000
		kW	3.5	4.1	5.3	7.0
	Heating	BTUh	13,500	15,600	20,000	27,000
		kW	4.0	4.6	5.9	7.9
Input power		W	30	42	74	99
Airflow rate	High	CFM (m ³ /h)	388 (660)	459 (780)	589 (1,000)	589 (1,000)
	Med		336 (570)	377 (640)	424 (720)	483 (820)
	Low		288 (490)	324 (550)	341 (580)	400 (680)
Sound pressure level	High	dB (A)	36	40	46	47
	Med		32	36	39	42
	Low		28	34	35	37
Dimensions (H × W × D)		in.(mm)	7-13/16 × 39 × 25-13/16 (199 × 990 × 655)			
Weight		lbs.(kg)	56 (25)	57 (26)	57 (26)	60 (27)
Connection pipe diameter	Liquid (Flare)	in.(mm)	1/4 (6.35)	1/4 (6.35)	3/8 (9.52)	3/8 (9.52)
	Gas (Flare)		1/2 (12.70)	1/2 (12.70)	5/8 (15.88)	5/8 (15.88)
Condensate Drain hose diameter (I.D./O.U.)			3/4" / 1-1/16"			

Note : Specifications are based on the following conditions.

Cooling : Indoor temperature of 80°F(26.7°C)DB/67°F(19.4°C)WB,and outdoor temperature of 95.0°F(35°C)DB/75°F(23.9°C)WB.

Heating : Indoor temperature of 70°F(21.1°C)DB/60°F(15.6°C)WB,and outdoor temperature of 47°F(8.3°C)DB/43°F(6.1°C)WB.

Pipe length : 25ft.(7.5 m), Height difference : 0ft.(0 m) (Outdoor unit - Indoor unit).

Built-in protective functions may limit capacity or shut off unit if unit is operated outside of unit design operating temperature ranges.

Flexible four-way louver swing

Combination of up/down and right/left directional louver swing provides excellent air distribution especially in large spaces.

RIGHT and LEFT SWING

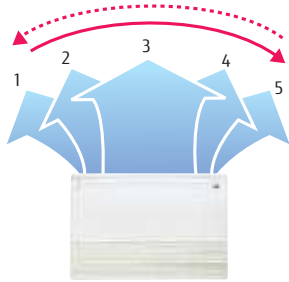

UP and DOWN SWING

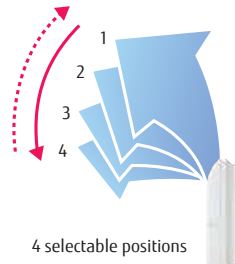

Auto-closing louver

When operation is stopped, the louvers will automatically close.

Compact design

Symmetric, slim and compact design.

Unit : in (mm)

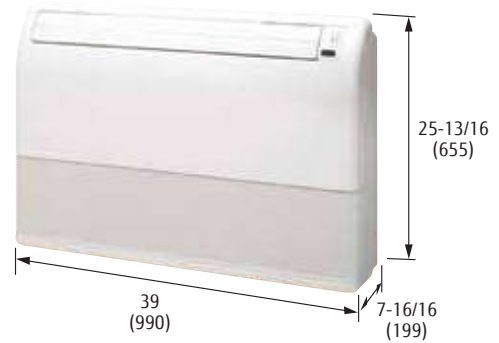

Efficient and powerful DC fan motor

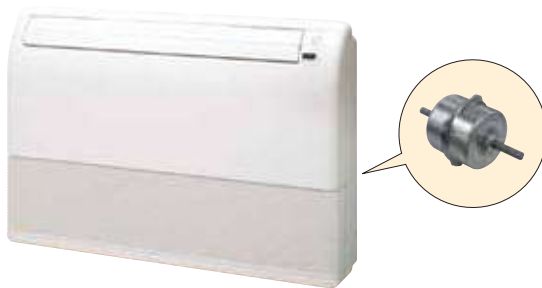

Dimensions

(Unit: In (mm))

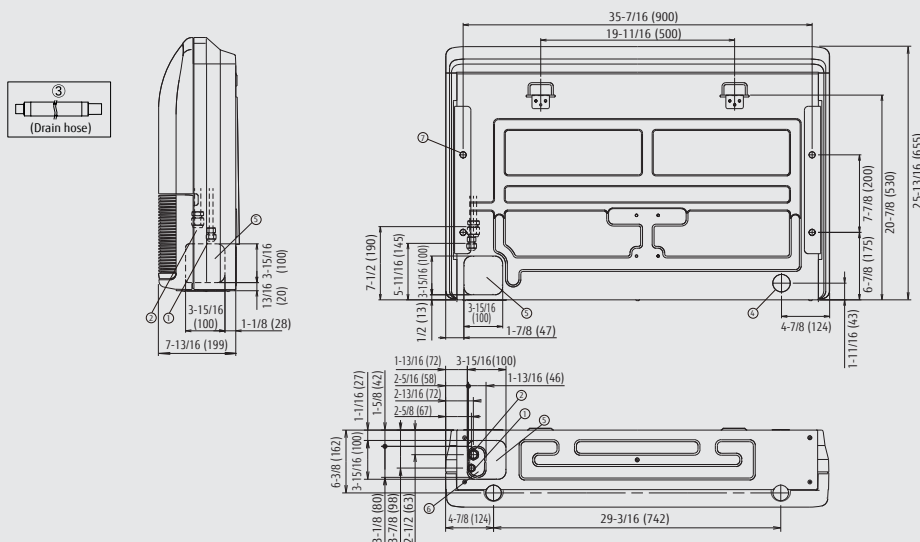

	ABUA 12/14	ABUA 18/24
① Refrigerant pipe flare connection (Liquid)	ø 1/4 (6.35)	ø 3/8 (9.52)
② Refrigerant pipe flare connection (Gas)	ø 1/2 (12.70)	ø 5/8 (15.88)
③ Drain hose connection (Drain Hose)	ø 3/4 (I.D.), ø 1-1/16 (O.D.)	
④ Knock out hole (Drain Outlet)	ø 1-3/4 (45)	ø 1-3/4 (45)
⑤ Knock out hole	—	—
⑦ Hole for lifting bolt	Use M10 screw bolt	

Ceiling

ABUA30TLAV / TLAV2

ABUA36RLAV / TLAV / TLAV2



Slim and elegant design makes the ceiling-suspended indoor unit a great fit for any light commercial applications such as retail stores, restaurants, conference rooms. Optimized air openings provide a comfortable air flow and low sound levels.

Note: IR Receiver is standard for communicating with optional Wireless Remote Control.

Installation

Open

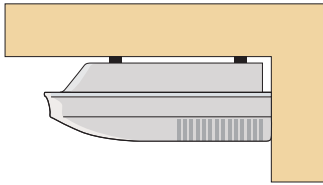

Standard installation with unit suspended from the ceiling.

Concealed

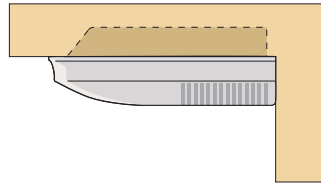

Partially recessed installation.

Wall mounted

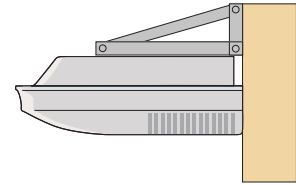

Efficient air distribution with long throw ensures comfort even in large rooms.

Slim & Compact design

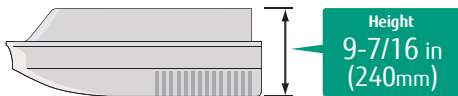

Height
9-7/16 in
(240mm)

Efficient and powerful DC fan motor



Specifications

Model name			ABUA30TLAV / TLAV2	ABUA36RLAV / TLAV / TLAV2
Power source			1 Phase - 208/230V 60Hz	
Capacity	Cooling	BTUh	30,000	36,000
		kW	8.8	10.6
	Heating	BTUh	34,000	40,000
		kW	10.0	11.7
Input power		W	85	85
Airflow rate	High	CFM (m ³ /h)	859 (1,630)	995 (1,690)
	Med		806 (1,370)	824 (1,400)
	Low		671 (1,140)	689 (1,170)
Sound pressure level	High	dB (A)	42	45
	Med		38	38
	Low		33	34
Dimensions (H x W x D)		in.(mm)	9-7/16 x 65-3/8 x 27-9/16 (240 x 1,660 x 700)	
Weight		lbs.(kg)	101 (46)	106 (48)
Connection pipe diameter	Liquid (Flare)	in.(mm)	3/8 (9.52)	3/8 (9.52)
	Gas (Flare)		5/8 (15.88)	3/4 (19.05)
Condensate Drain hose diameter (I.D./O.U.)			3/4" / 1-1/16"	

Note : Specifications are based on the following conditions.

Cooling : Indoor temperature of 80°F (26.7°C) DB/67°F (19.4°C) WB, and outdoor temperature of 95.0°F (35°C) DB/75°F (23.9°C) WB.

Heating : Indoor temperature of 70°F (21.1°C) DB/60°F (15.6°C) WB, and outdoor temperature of 47°F (8.3°C) DB/43°F (6.1°C) WB.

Pipe length : 25ft. (7.5 m), Height difference : 0ft. (0 m) (Outdoor unit - Indoor unit).

Built-in protective functions may limit capacity or shut off unit if unit is operated outside of unit design operating temperature ranges.

Four-way louver swing

Auto airflow direction and auto swing
Right and left

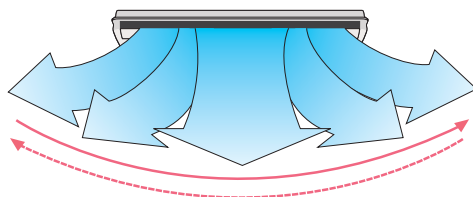

5 selectable positions

Up and down

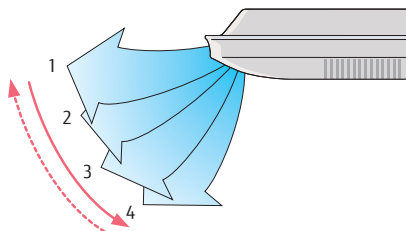

4 selectable positions

Efficient air distribution

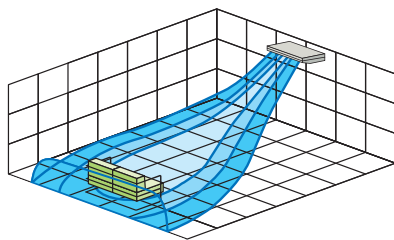

Condensate drain pump (Optional)

Installation flexibility with optional condensate drain pump.

Height
19-11/16 in
(500mm)

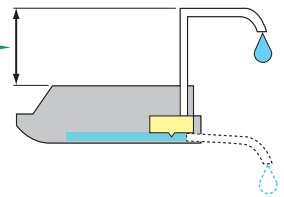

Outside air intake

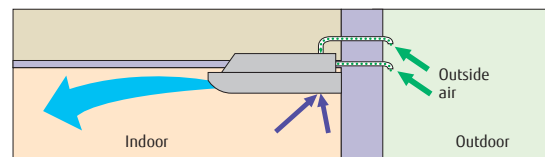

Air filter

High Efficiency long-life filter can double the life of the filter compared to standard filters.

Optional parts

Drain Pump Unit.....UTZ-PU1EBA / UTR-DPB24T
Flange.....UTD-RF204

Dimensions

(Unit: In (mm))

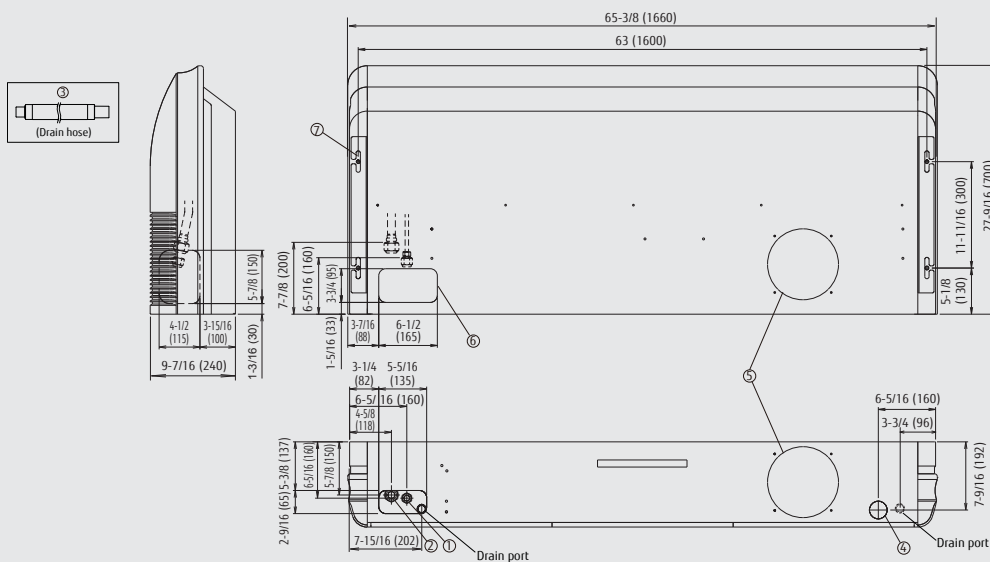

	ABUA 30	ABUA 36
① Refrigerant pipe flare connection (Liquid)	ø 3/8 (9.52)	ø 3/8 (9.52)
② Refrigerant pipe flare connection (Gas)	ø 5/8 (15.88)	ø 3/4 (19.05)
③ Drain hose connection (Drain Hose)	ø 3/4 (I.D.), ø 1-1/16 (O.D.)	
④ Knock out hole (Drain Outlet)	ø 1-15/16 (50)	ø 1-15/16 (50)
⑤ Knock out hole (Fresh Air)	ø 7-7/8 (200)	ø 7-7/8 (200)
⑥ Knock out hole (Refrigerant Pipe)	—	—
⑦ Hole for lifting bolt	Use M10 screw bolt	

Compact Wall Mounted

ASUA4TLAV1 / TLAV2

ASUA7TLAV1 / TLVA2

ASUA9RLAV / TLAV1 / TLAV2

ASUA12RLAV / TLVA2

ASUA14RLAV / TLAV / TLAV1 / TLAV2



4/7/9,000 BUTH



12/14,000 BTUH

Easy Installation

Wiring can be easily connected by opening the front panel and wire cover.

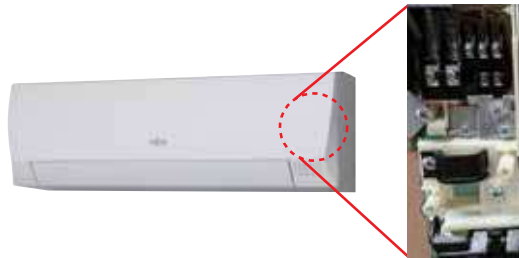

High density heat exchanger

Increased heat transfer efficiency with thin tube technology.

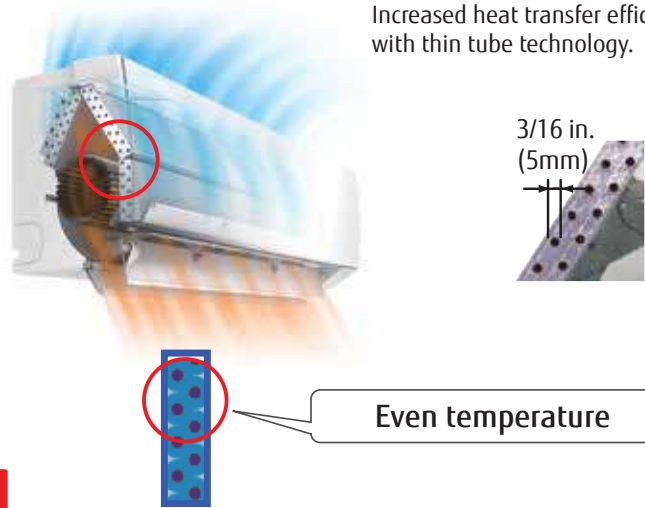

Quiet operation

Improved airflow pattern reduces noise significantly.

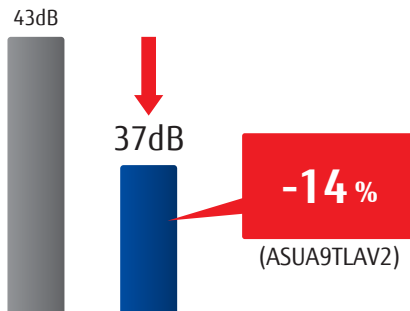

Specifications

Model name		ASUA4TLAV1 / TLAV2	ASUA7TLAV1 / TLVA2	ASUA9RLAV / TLAV1 / TLAV2	ASUA12RLAV / TLVA2	ASUA14RLAV / TLAV / TLAV1 / TLAV2	
Power Source		1 Phase - 208 / 230V ~ 60Hz					
Capacity	Cooling	BTU/h	4,000	7,500	9,500	12,000	14,000
		kW	1.2	2.2	2.8	3.5	4.2
Capacity	Heating	BTU/h	4,400	9,500	10,900	13,500	15,600
		kW	1.3	2.8	3.2	4.0	4.6
Input Power		W	13	19	34	25	36
Airflow rate	High	CFM (m ³ /h)	253 (430)	324 (550)	424 (720)	406 (690)	471 (800)
	Med-Hi		247 (420)	271 (460)	336 (570)	359 (610)	436 (740)
	Med		230 (390)	247 (420)	294 (500)	330 (560)	400 (680)
	Lo-Hi		224 (380)	230 (390)	241 (410)	312 (530)	359 (610)
	Low		212 (360)	212 (360)	212 (360)	277 (470)	324 (550)
	Quiet		194 (330)	194 (330)	194 (330)	194 (330)	194 (330)
Sound pressure level	High	dB(A)	31	35	43	40	44
	Med-Hi		30	32	38	37	42
	Med		28	30	34	35	40
	Lo-Hi		26	27	29	33	37
	Low		24	24	24	30	34
	Quiet		22	22	22	24	24
Dimensions (H x W x D)		in. (mm)	10-5/16 x 32-5/16 x 8-1/8 (262 x 820 x 206)			10-9/16 x 33-1/16 x 8 (268 x 840 x 203)	
Weight		lbs. (kg)	17 (7.5)	17 (7.5)	17 (7.5)	20 (9)	20 (9)
Connection pipe diameter	Liquid (Flare)	in. (mm)	Ø1/4 (6.35)	1/4 (6.35)	1/4 (6.35)	1/4 (6.35)	1/4 (6.35)
	Gas (Flare)		Ø3/8 (9.52)	3/8 (9.52)	3/8 (9.52)	1/2 (12.70)	1/2 (12.70)
Condensate Drain hose diameter (I.D./O.D.) in.			9/16 / 5/8 to 11/16				

Note : Specifications are based on the following conditions: Built-in protective functions may limit capacity or shut off unit if unit is operated outside of unit design operating temperature ranges.

Cooling : Indoor temperature of 80°F(26.7°C)DB/67°F(19.4°C)WB; and outdoor temperature of 95°F(35°C)DB/75°F(23.9°C)WB. Heating : Indoor temperature of 70°F(21.1°C)DB/60°F(15.6°C)WB, and outdoor temperature of 47°F(8.3°C)DB/43°F(6.1°C)WB. Pipe Length : 25ft. (7.5m), Height difference : 0ft.(0m)(Outdoor unit - indoor unit).

*Cooling / Heating

6-speed fan control (ASUA4TLAV1 only)

With 6 fan speeds to choose from, these wall mounted models operate as quietly as 22 dB(A).

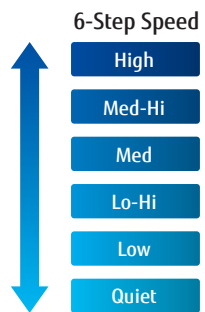

Six-speed fan control available through the following Remotes and Controllers:
 UTY-RNRUZ* / UTY-RSRY / UTY-RHRY / UTY-DCGY / UTY-DTGYZ1 / UTY-ALGXZ1 / UTY-APGXZ1

Comfortable airflow

Models ASUA12/14TLAV1
UNIQUE POWER DIFFUSER

Heating

Vertical airflow provides powerful floor level heating

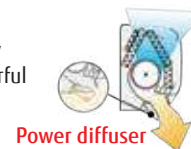

Cooling

Horizontal airflow does not supply cool air directly at the occupants in the room.

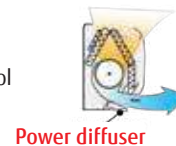

Occupancy / Human sensor function

Models ASUA12/14TLAV1

The energy saving occupancy function can, via the optional Wired Remote Controller, be set to turn off the unit or change to power saving mode when a room becomes unoccupied.



Human sensor

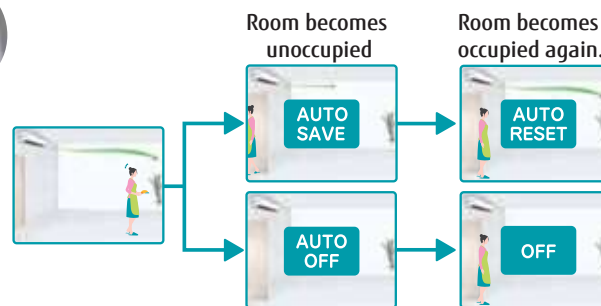

Powerful airflow



Optional parts

- Wired Remote Control (Touch Panel):..... UTY-RNRUZ*
- Wireless Remote Control:.....UTY-LNHU
- Simple Remote Control:.....UTY-RSRY, UTY-RHRY

Dimensions

Models:

ASUA4TLAV1 / ASUA7TLAV1 / ASUA9TLAV1

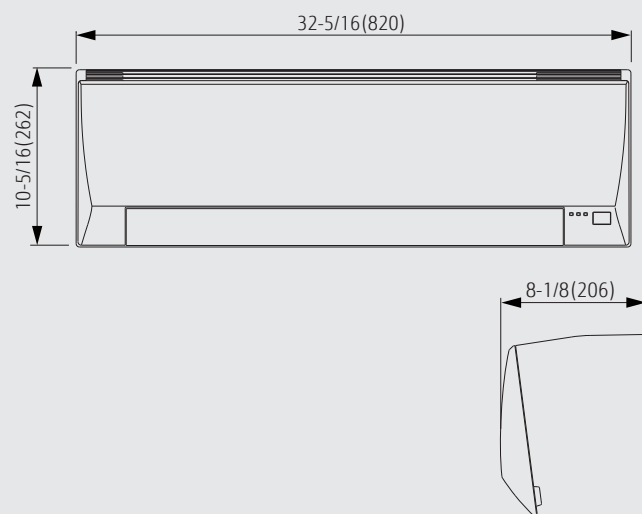

(Unit: In (mm))

Models:

ASUA12TLAV1/ASUA14TLAV1

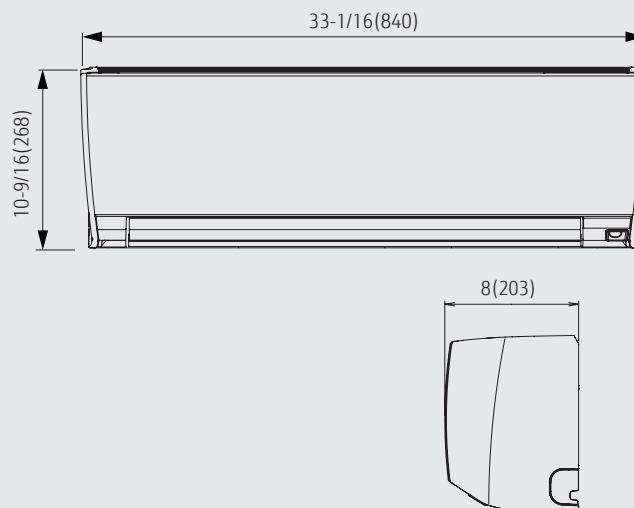

Wall Mounted

ASUB18TLAV1

ASUB24TLAV1

ASUA30TLAV2

ASUA36TLAV1 / TLAV2



18/24,000 BTU/h



30/36,000 BTU/h

Comfortable air distribution

Power diffuser
(ASUB18/24TLAV1)

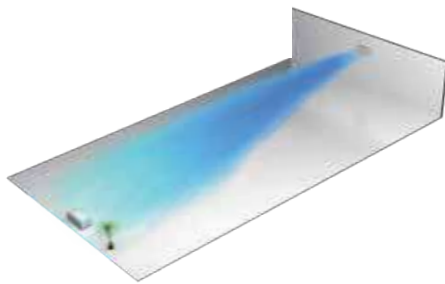
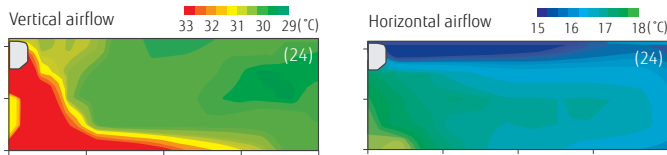

Occupancy / Human sensor setting

Models ASUB30/36TLAV1 only

The energy saving occupancy function can, via the optional Wired Remote Controller, be set to turn off the unit or change to power saving mode when a room becomes unoccupied.

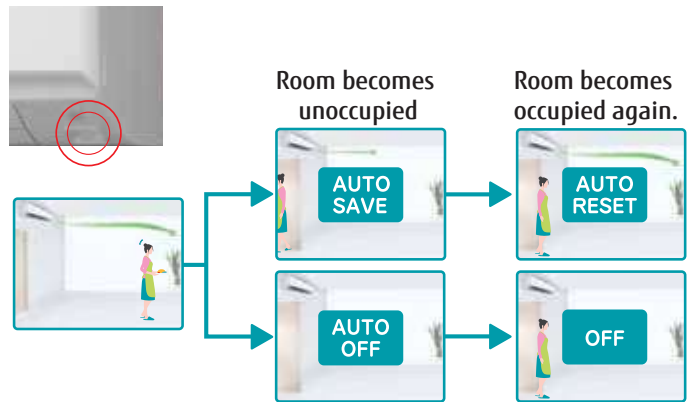

Specifications

Model name		ASUB18TLAV1	ASUB24TLAV1	ASUA30TLAV2	ASUA36TLAV1 / TLAV2	
Power Source		1 Phase - 208 / 230V ~ 60Hz				
Capacity	Cooling	BTU/h	18,000	24,000	30,000	34,000
		kW	5.3	7.0	8.8	10.0
Capacity	Heating	BTU/h	20,000	27,000	34,000	38,000
		kW	5.9	7.9	10.0	11.2
Input Power		W	32	60	74	103
Airflow rate	High	CFM (m ³ /h)	494 (840)	647 (1,100)	848 (1,440)	954 (1,620) / 895 (1,520)*
	Med-Hi		-	-	706 (1,200)	765 (1,300)
	Med		453 (770)	536 (910)	618 (1,050)	659 (1,120)
	Lo-Hi		-	-	553 (940)	577 (980)
	Low		406 (690)	430 (730)	524 (890)	524 (890)
Sound pressure level	Quiet	dB(A)	-	-	412 (700)	412 (700)
	High		41	48	53	55 / 54 *
	Med-Hi		-	-	49	51
	Med		39	43	45	47
	Lo-Hi		-	-	42	43
Dimensions (H x W x D)	in. (mm)	12-5/8 x 39-5/16 x 9-3/8 (320 x 998 x 238)			13-3/8 x 45-1/4 x 11 (340 x 1,150 x 280)	
	Weight	lbs. (kg)	33 (15)	33 (15)	40 (18)	40 (18)
	Connection pipe diameter	Liquid (Flare)	in. (mm)	1/4 (6.35)	3/8 (9.52)	3/8 (9.52)
Gas (Flare)		in. (mm)	1/2 (12.70)	5/8 (15.88)	5/8 (15.88)	5/8 (15.88)
Drain hose diameter (I.D./O.D.)		in. (mm)	9/16 / 5/8 to 11/16			

Note : Specifications are based on the following conditions: Built-in protective functions may limit capacity or shut off unit if unit is operated outside of unit design operating temperature ranges.

Cooling : Indoor temperature of 80°F (26.7°C) DB/67°F (19.4°C) WB; and outdoor temperature of 95°F (35°C) DB/75°F (23.9°C) WB. Heating : Indoor temperature of 70°F (21.1°C) DB/60°F (15.6°C) WB, and outdoor temperature of 47°F (8.3°C) DB/43°F (6.1°C) WB. Pipe Length : 25ft. (7.5m), Height difference : 0ft. (0m) (Outdoor unit - indoor unit).

*Cooling / Heating

6-speed fan control

With 6 fan speeds to choose from, these wall mounted models operate as quietly as 33 dB(A).
 Note: This applies to models ASUB30TLAV1 and ASUB36TLAV1.

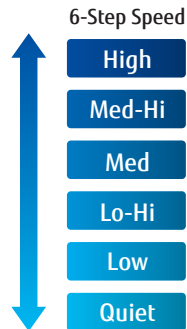
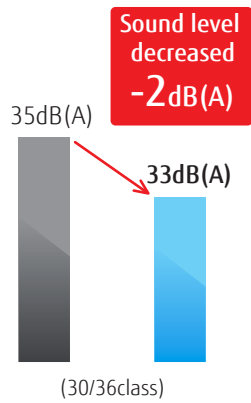

* Compatible Remote Controller is as follows:
 UTY-RNRUZ Series / UTY-RSRY / UTY-RHRY / UTY-DCGYZ2 / UTY-DTGYZ1 / UTY-ALGXZ1 / UTY-APGXZ1

Optional parts

Wired Remote Control (Touch Panel) UTY-RNRUZ*
 Wireless Remote Control..... UTY-LNHU
 Simple Remote Control..... UTY-RSRY, UTY-RHRY

Dimensions

(Unit: In (mm))

Models:
 ASUB18TLAV1 / ASUB24TLAV1

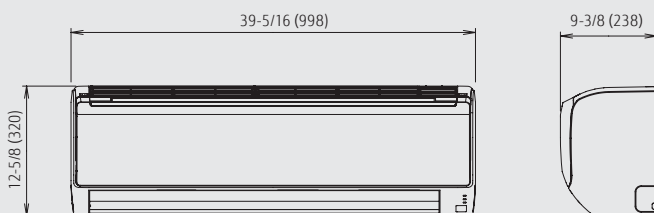

Models:
 ASUB30TLAV1 / ASUB36TLAV1

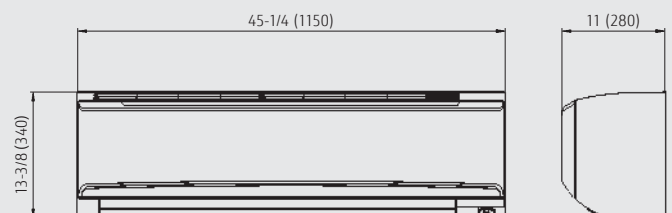

VENTILATION

VENTILATION Lineup

- p. 74 DX Kit
- p. 76 Outdoor Air Unit
- p. 78 HRV / ERV Solutions



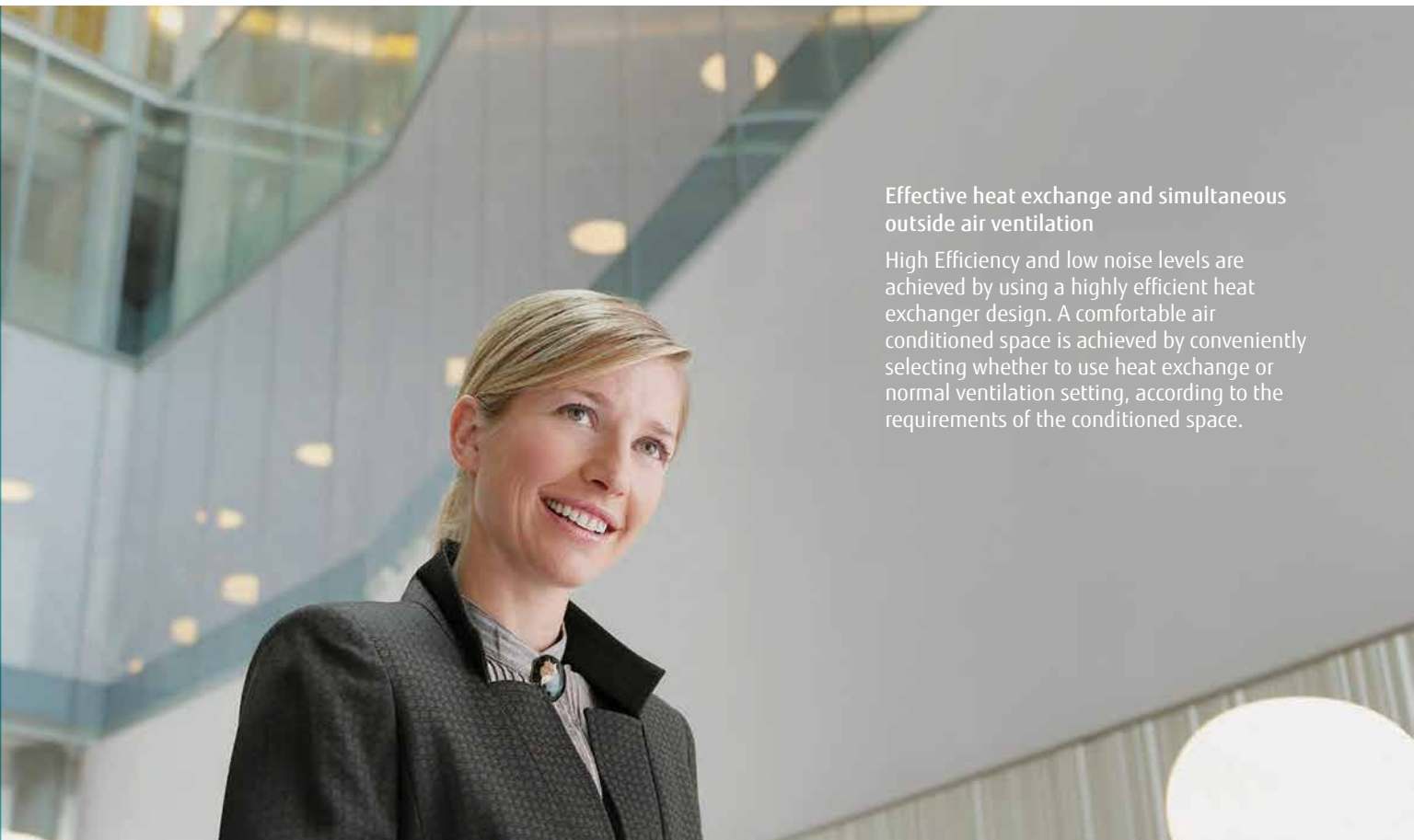

Effective heat exchange and simultaneous outside air ventilation

High Efficiency and low noise levels are achieved by using a highly efficient heat exchanger design. A comfortable air conditioned space is achieved by conveniently selecting whether to use heat exchange or normal ventilation setting, according to the requirements of the conditioned space.

Lineup

Connectable capacity (BTU/h)	18,000	24,000	30,000	36,000	48,000	60,000	72,000	96,000	144,000	168,000
DX-Kit for connection of third-party AHU										
	EEV Unit UTP-VU30A	Control Box UTU-VDGU	EEV Unit UTP-VU60A	Control Box UTU-VDGU	EEV Unit UTP-VU90A	Control Box UTU-VDGU	EEV Unit UTP-VU90Ax2	Control Box UTU-VDGU	EEV Unit UTP-VU90Ax2	Control Box UTU-VDGU

Outdoor Air Unit			
	AAUA48TLAV	AAUA72TLAV	AAUA96TLAV

HRV / ERV							
	VS500SQ / VS500Sqe	VS250 CMh/e	VS400 CMh/e	VS900 CMh/e	VS1200 CMh/e	VS1000RT/RTe	VS3000RT/RTe

DX-Kit for air handling applications

- UTP-VU30A
- UTP-VU60A
- UTP-VU90A
- UTY-VDGU

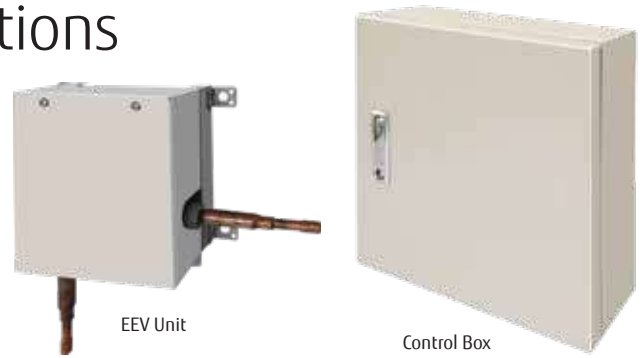

Fujitsu's DX-Kit enables a 3rd party Air Handling Unit to be fully integrated into an Airstage VRF system. This enables the benefits of advanced inverter compressor technology to extend to standard air handling equipment.

The DX-Kit offers a seamless integration and optimized design flexibility while making installation and commissioning efficient.

Different control strategies for optimized control of air handling & fan coil units

- When connecting to an air handling unit, the supply air temperature can be controlled by the air discharge sensor.
- When connecting to a fan coil unit, the room temperature can be controlled by the return air temperature sensor.

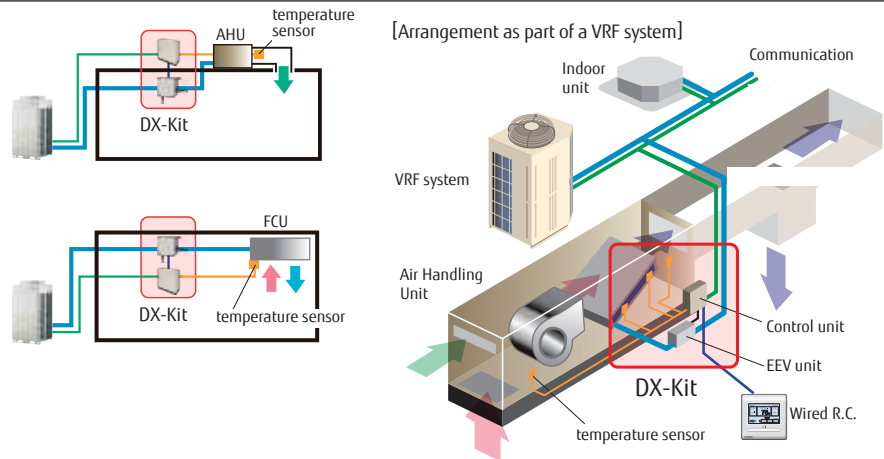

Supports wide range of capacities

- Connectable capacity range: 18,000 BTU/h to 168,000 BTU/h.
- 2 EEV units can be connected in parallel for up to 168,000 BTU/h large capacity units.

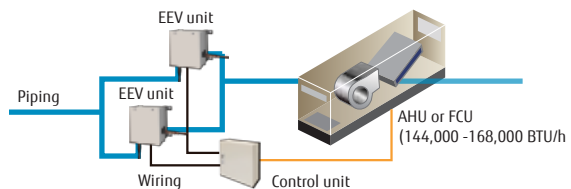

Variety of controls to match the application

- Central control using VRF controllers or central management (BMS) controller.

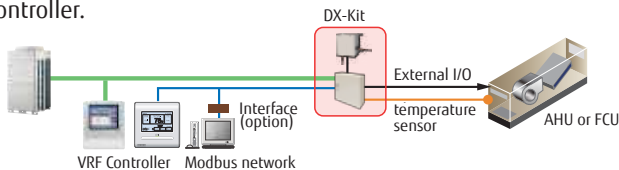

- Central control from external 3rd party controller

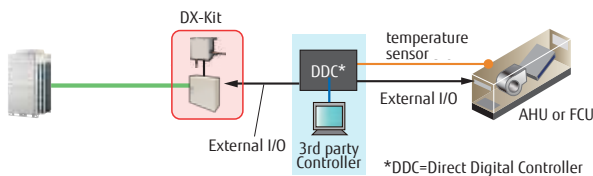

*DDC=Direct Digital Controller

Summary of input/output functions

Inputs

- ON/OFF
- Set temperature
- Capacity demand
- Heating / Cooling operation mode
- Fault information

Outputs

- ON/OFF indication
- Fan ON/OFF indication
- Thermo ON/OFF indication
- Defrost indication
- Fault indication

Modbus control

- Possible to control via Modbus interface for integration into a BMS system.

DX-Kit system design parameters

- Connectable VRF series: J-III, J-IV, J-IVS, V-II, VR-II
- Connectable DX-Kit system capacity range: 50 to 100% of the outdoor unit capacity
- Connectable DX-Kit system capacity range with indoor units: 30% or less of the outdoor unit capacity
- Max wiring length from control unit: 32ft. (10m)
- Max piping length between EEV unit and indoor unit: 16ft. (5m)
- Control unit and EEV unit can be installed outdoors.

[Connectable capacity]

- Single connection

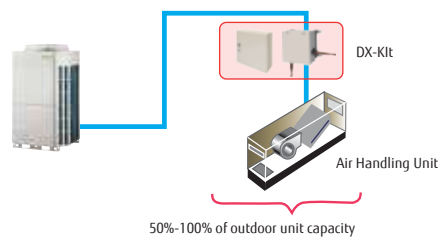

- Mixed connection

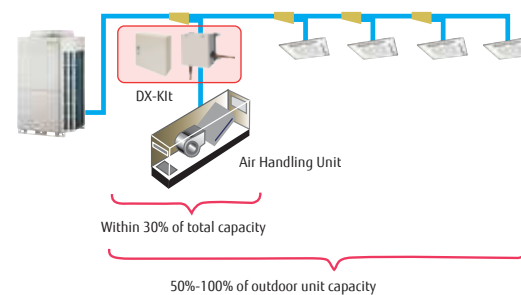

[Piping and wiring length]

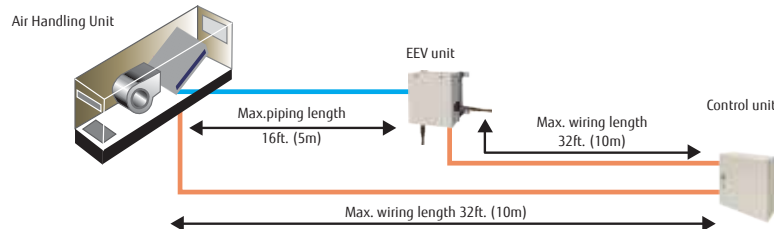

[For 2EEV units connection (option)]

- Separation Tube kit : UTP-LX180A



Specifications

EEV Unit		UTP-VU30A			UTP-VU60A			UTP-VU90A		UTP-VU90A×2	
Connectable capacity	BTU/h	18,000	24,000	30,000	36,000	48,000	60,000	72,000	96,000	144,000	168,000
Capacity	Cooling	18,000	24,000	30,000	36,000	48,000	60,000	72,000	96,000	144,000	168,000
	Heating	20,000	27,000	34,000	40,000	54,000	67,000	81,000	108,000	162,000	188,000
Airflow Rate(Reference value)	CFM (m ³ /h)	624 (1,060)	706 (1,200)	895 (1,520)	941 (1,600)	1,177 (2,000)	1,318 (2,240)	2,095 (3,560)	2,354 (4,000)	3,767 (6,400)	4,709 (8,000)
Dimensions (H×W×D)	in. (mm)	6-5/16 x 8-11/16 x 3-9/16 (160 × 220 × 90)								6-5/16 x 8-11/16 x 3-9/16 (160 × 220 × 90) × 2	
Weight	lbs. (kg)	4.4 (2.0)								4.4 (2.0) × 2	
Connection pipe diameter (Liquid)	in. (mm)	ø3/8 (9.52)			ø3/8 (9.52)			ø1/2 (12.70)			
Control box		UTY-VDGU									
Power source	V/ø/Hz	208-230 / 1 / 60									
Dimensions (H×W×D)	in. (mm)	15-3/4 x 15-3/4 x 4-3/4 (400 × 400 × 120)									
Weight	lbs. (kg)	22.0 (10.0)									

Note: Specifications are based on the following conditions:

Cooling: Indoor temperature of 80°F(26.7°C)DB/67°F(19.4°C)WB, and outdoor temperature of 95°F(35°C)DB/75°F(23.9°C)WB.

Heating: Indoor temperature of 70°F(21.1°C)DB/60°F(15.6°C)WB, and outdoor temperature of 47°F(8.3°C)DB/43°F(6.1°C)WB.

Pipe length: 25ft. (7.5 m)

Voltage : 230 [V]

Outdoor Air Unit

AAUA48TLAV

AAUA72TLAV

AAUA96TLAV

The outdoor air unit provides a zoned and decentralized solution to bringing in conditioned outside air to the space. Both outside air treatment and space conditioning is provided from one flexible and efficient VRF system.



AAUA48



AAUA72



AAUA96

One VRF system can provide efficient air conditioning and air supply at the same time

J-SERIES V-SERIES

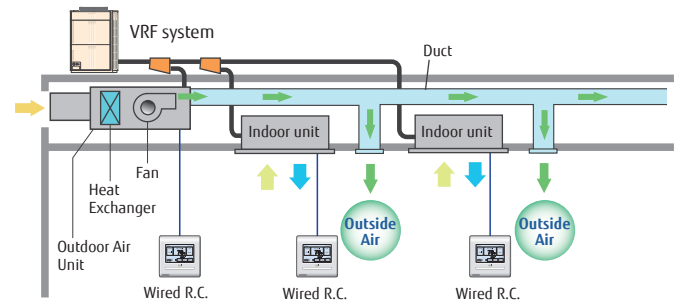
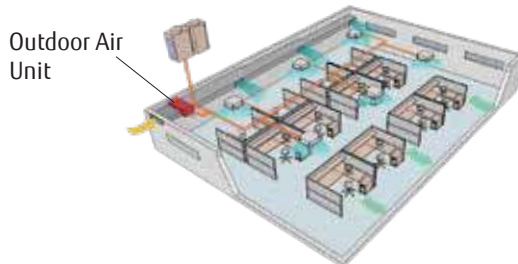

* See Product Documentation for detailed design guidelines.

Model name			AAUA48TLAV	AAUA72TLAV	AAUA96TLAV
Power source			1 Phase - 208/230V 60Hz		
Capacity	Cooling	BTUh	48,000	72,000	96,000
	Heating		30,000	47,000	59,000
Input power	Cooling/Heating	W	179	292	370
Airflow rate		CFM	636	989	1,236
		(m ³ /h)	(1,080)	(1,680)	(2,100)
Static pressure range		in.WG	0.20 to 0.74 (50 to 184)	0.20 to 0.80 (50 to 200)	0.20 to 0.96 (50 to 239)
Standard static pressure		(Pa)	0.74 (184)	0.80 (200)	0.80 (200)
Sound pressure level		dB (A)	42	44	47
Dimensions (H × W × D)		in.	16-3/4×53-13/16×22-1/2	16-3/4×53-13/16×22-1/2	17-11/16×62-5/16×27-9/16
		(mm)	(425×1,367×572)	(425×1,367×572)	(450×1,583×700)
Weight		lbs. (kg)	108 (49)	123 (56)	159 (72)
Connection Pipe Diameter (Small / Large)		in.	Ø3/8 / Ø3/4	Ø1/2 / Ø7/8	Ø1/2 / Ø7/8
		(mm)	(Ø9.52 / Ø19.05)	(Ø12.70 / Ø22.22)	(Ø12.70 / Ø22.22)
Operation Range	Cooling	°FDB	41 to 109 (5 to 43)	41 to 109 (5 to 43)	41 to 109 (5 to 43)
	Heating	(°CDB)	19 to 70 (-7 to 21)	19 to 70 (-7 to 21)	19 to 70 (-7 to 21)
Refrigerant			R410A	R410A	R410A

Note : Specifications are based on the following conditions.

Cooling : Outdoor temperature of 91°FDB (33°CDB) / 82°FWB (28°CWB).

Heating : Outdoor temperature of 32°FDB (0°CDB) / 27°FWB (-2.9°CWB).

Pipe length : 25ft. (7.5 m)

High energy savings and flexible duct design by using DC motor

- DC fan motor with permanent magnet technology for energy efficient operation.
- External static pressure capabilities of up to 0.96" W.G. allows for flexibility with duct work and filtration choices.

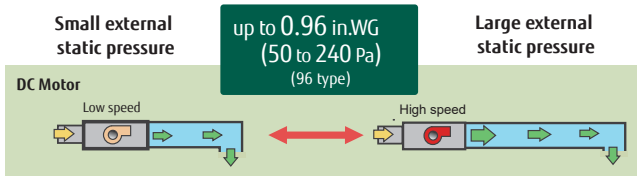
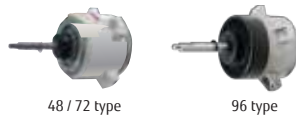

Various Controllers

Design flexibility with many optional controllers, such as individual remote controls, central controllers and building management systems.

Remote Controls



Central Controller



Top class compact design

- Compact and low profile design reduces the required installation space and can eliminate mechanical rooms or separate mounting spaces associated with traditional outdoor air systems.

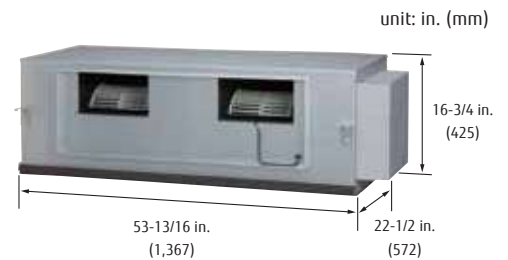

AAUA48TLAV

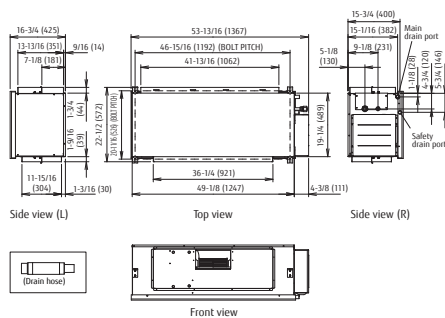

AAUA72TLAV

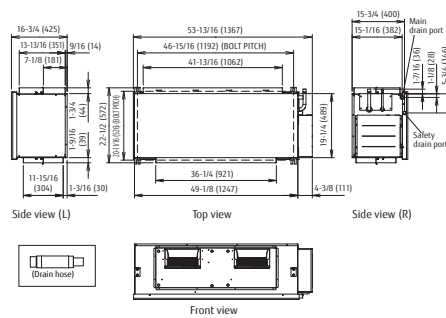

AAUA96TLAV

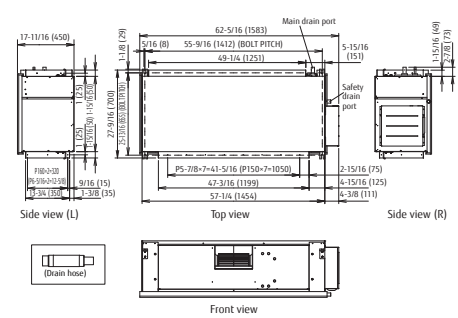

HRV / ERV Solutions

Improved comfort and health in buildings

When the Ventacity HRV/ERV system is connected to optional sensors, it will optimize ventilation, providing just the right amount of outside air when and where needed for maximum health and comfort. The combination of zoned heating and cooling from Airstage systems with outside air from Ventacity's HRV/ERV systems provides a healthy environment for building occupants, translating into higher building value.

High Efficiency

The Airstage VRF system - which includes a variety of Building Management System controls - combined with a Ventacity HRV/ERV system makes an intelligent, ultra-efficient solution for buildings, offering tremendous Energy Use Intensity (EUI) reductions and savings in the building's annual energy use per unit area.

Specifications

		Indoor Mount Ductless	Above Drop Ceiling Ventilator	Above Drop Ceiling Ventilator	Above Drop Ceiling Ventilator	Above Drop Ceiling Ventilator	Roof Top Mounted Ducted	Roof Top Mounted Ducted
MODEL NAME		VS500SQ / VS500Sqe	VS250 CMh/e	VS400 CMh/e	VS900 CMh/e	VS1200 CMh/e	VS1000RT/RTe	VS3000RT/RTe
Ventilation Flow - Max	cfm	539	309	467	992	1492	1,020 cfm	3,300 cfm
Ventilation Flow - Typical	cfm	117 to 500	60 to 270	120 to 480	200 to 900	300 to 1200	180 to 1,000 cfm	750 to 3,000 cfm
Ventilation Type		Heat Recovery Ventilator (HRV) / Energy Recovery Ventilator (ERV)						
Heat Exchanger		Counterflow Aluminum Static Plate / Counterflow Polymer Static Plate						
Heat Recover - Max	%	90 / 83	86.1/79.2	86.1/79.2	86.1/79.2	86.1/77.9	92 / 85	90 / 85
Temperature Range	°F	40 to 104	41 to 104	41 to 104	41 to 104	41 to 104	-13 to 140	-13 to 122
Modes		CAV, DCV, Economizer	CAV, DCV, VAV, BMS, Economizer				CAV, DCV, VAV, BMS, Economizer	
MECHANICAL								
Weight	lbs.	280 / 288	165	210	375	540	618 / 662	1654 / 1720
Dimensions	in.	84.3 x 44 x 17.9	46.9 x 12.2 x 30.7	55.1 x 12.2 x 42.5	66.9 x 15.4 x 54.5	78.7 x 18.5 x 67.3	63.6 x 35.2 x 52.5	86.3 x 48.3 x 73.5
OA Filter (2" or 4") MERV13	in.	15.16 x 16 x 3.75	11.2 x 9.25 x 3.78	17.9 x 9.25 x 3.78	23.03 x 12.2 x 3.78	29.53 x 15.55 x 3.78	17.5 x 28 x 3.75	51 x 26.5 x 3.75
RA Filter (2") MERV8	in.	10.6 x 16.7 x 2	11.2 x 9.25 x 3.78	17.9 x 9.25 x 3.78	23.03 x 12.2 x 3.78	23.03 x 12.2 x 3.78	16.5 x 28 x 17.5	51 x 25.25 x 3.75
ELECTRICAL								
Power Supply	kW	5.1	1.78	3.29	6.26	7.9	7	20.2
Voltage		240 VAC, 1-Phase, 60Hz	208-240 VAC	208-240 VAC	208-240 VAC	208-240 VAC	240 VAC, 1-Phase, 60Hz or 208/240 VAC, 3-Phase, 60Hz	*208/240 VAC, 3-Phase, 60Hz or 480 VAC, 3-Phase, 60Hz*
De-Ice Preheater	kW	2.1	1.51	2.93	5.3	6.9	6	16.3
Maximum Power - 1 Fan	W	322	125	170	470	503	500	1,900

Ductless

The VS500SQ is a ductless HRV/ERV for decentralized applications. The VS500SQ optimizes for energy efficiency and healthy indoor air quality, while offering ultra-quiet operation and no drafts.

Top Applications: Classrooms, offices and conference rooms.



Ventilator

VS-CM Series HRVs & ERVs for installation above drop ceilings. Operates at much higher energy efficiency (up to 93%) which saves much more energy and significantly lowers operating costs. Four capacities to choose from.



Ducted

VS1000RT and VS3000RT make up a line of Smart Ventilation™ Management systems with a rugged design for easy rooftop or mechanical room installation that optimize healthy indoor air quality while minimizing building energy usage.

Top Applications: New and existing retail spaces, offices, restaurants, schools, public spaces and multifamily residential buildings.



Passive House certified

The VS1000RT is the first Passive House, UL, CSA Certified counterflow heat recovery ventilation (HRV) product in North America.





Light Commercial & Commercial CONTROL SYSTEMS OPTIONAL PARTS & ACCESSORIES



- p. 82 Control System Overview
- p. 84 Remotes & Controllers Features Table
- p. 112 Optional Parts Overview



The flexibility of the Airstage controls architecture meet customer needs through a variety of offerings. Available are wired and wireless individual remote controllers, central remote controllers that simultaneously control multiple indoor units, and a variety of converters that link with other systems.

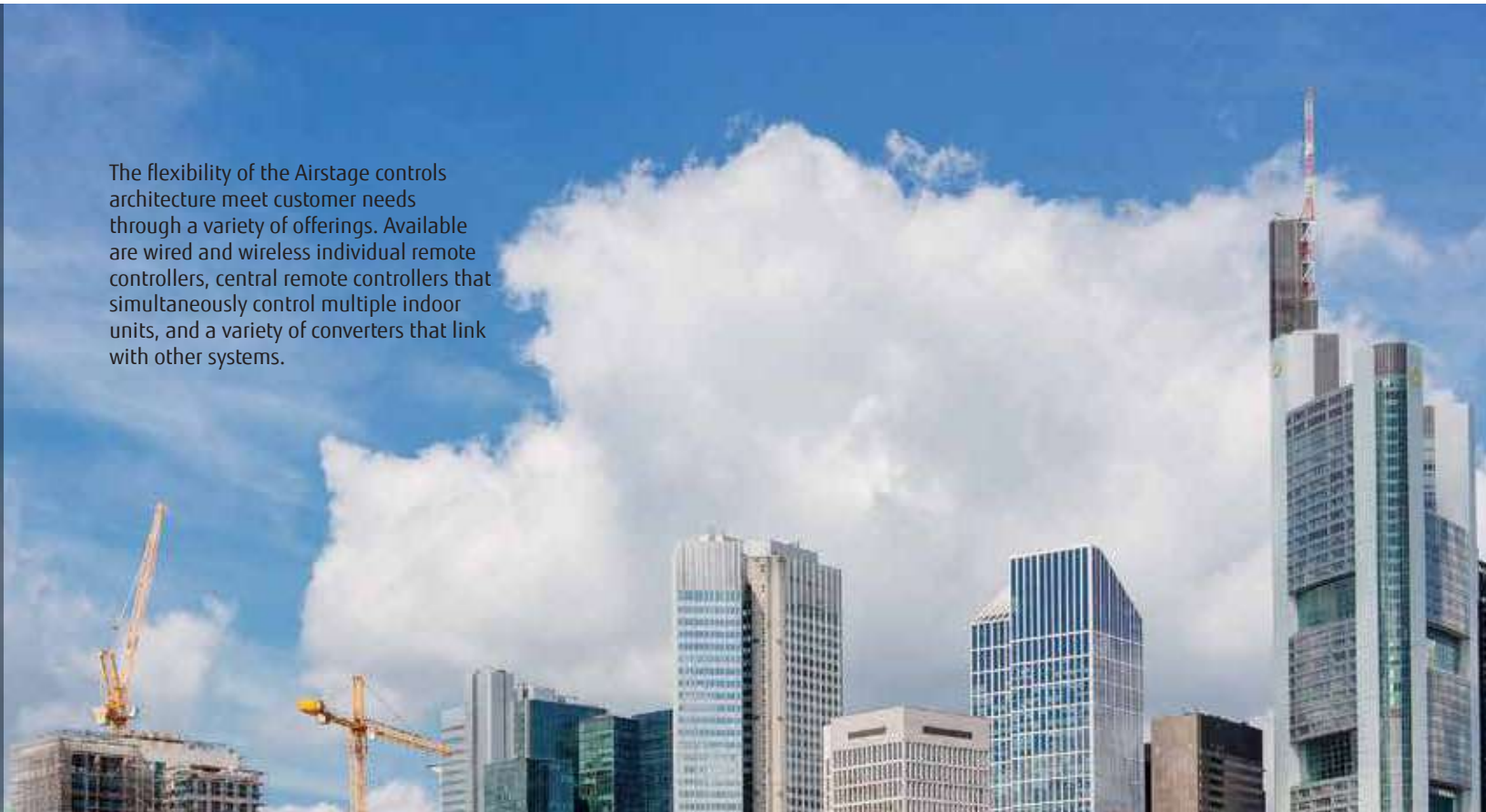

CONTROL SYSTEMS



INDIVIDUAL CONTROLS

- p. 85 Touch Panel Wired Remote Control
- p. 87 Simple Remote Control
with or without Operation Mode
- p. 88 Wireless Handheld Remote Control
- p. 88 IR Receiver Units

CENTRAL CONTROLLERS

- p. 89 Touch Panel Controller w/Internet
- p. 91 Central Remote Controller
- p. 92 Central Controller
- p. 93 System Controller **Software**
- p. 93 System Controller Lite **Software**

BMS COMMUNICATION OPTIONS

- p. 97 Airstage Integration Manager™
(powered by Niagara)
- p. 99 BACnet® Gateway **Hardware**
- p. 99 BACnet® Gateway **Software**
- p. 100 Network Converter for LONWORKS®
- p. 100 MODBUS® Converter

Wi-Fi INTERFACES

- p. 101 UART Wi-Fi Adapter - FGLair
- p. 101 UART Wi-Fi Adapter- AC Cloud Control
- p. 101 3-Wire Wi-Fi Adapter - AC Cloud Control



CONVERTERS / ADAPTERS

- p. 102 Network Converters
- p. 102 Signal Amplifier
- p. 103 External Switch Controller
- p. 104 3rd Party Thermostat Converter

SERVICE & MONITORING

- p. 105 Service Tool **Software**
- p. 107 Web Monitoring Tool **Software**

DESIGN TOOLS

- p. 108 Design Simulator
- p. 109 BIM
- p. 110 CYPETHERM
- p. 111 ORACLE CPQ

OPTIONAL PARTS & ACCESSORIES



ACCESSORIES

- p. 112 Accessories for Ducted Units, Large
Cassette, Compact Cassette
- p. 113 External Power Supply Unit
- p. 114 Separation Tubes etc.
- p. 115 RB Units
- p. 116 Auto Louver Grille Kit
- p. 117 Wind Baffles, Hail Guards, Snow
Hoods
- p. 118 Airzone
- p. 119 Hirise 360 Kit



VRF J Series



VRF V Series

Control System Overview

For VRF

User's needs are supported by offering a variety of controls, such as individual control, central control and building management control options.

Air Conditioning Individual Control



Touch Panel Wired Remote Control
UTY-RNRUZ*

p. 85



Simple Remote Control
UTY-RSRY
UTY-RHRY (without operation mode)

p. 87



Wireless Remote Control
UTY-LNHU

p. 88



IR Receiver Unit
UTB-YWC For Ducted Models
UTY-TRHX For TLAV2 Ducted Models

p. 88



UTY-LRHYB1 For Cassette
UTY-LBHXD For Circular Flow Cassette

p. 88

Air Conditioning Centralized Control



Touch Panel Controller
UTY-DTGYZ1

p. 89



Central Remote Controller
UTY-DCGYZ2

p. 91



Central Controller
UTY-DCGY

p. 92



System Controller Software
UTY-APGXZ1
UTY-ALGXZ1 (Lite edition)

p. 93



BMS Gateways

For external control via Building Management Systems (BMS) or Home Automation Systems (HAS)

Airstage Integration Manager™
powered by Niagara
FUJ-VRF-8025
FUJ-VRF-8125



p. 97

BACnet® Gateway
UTY-VBGX **Hardware**



p. 99

BACnet® Gateway
UTY-ABGXZ1 **Software**



Network Converter
(For LONWORKS®)
UTY-VLGX



p. 100

MODBUS® Converter
UTY-VMGX
UTY-VMGU-KIT



p. 100

Wi-Fi Interfaces

For control via cloud-based applications

UART Wi-Fi Adapter
(AC Cloud Control)
FJ-AC-WIFI-1



UART Wi-Fi Adapter
(FGLAir)
UTY-TFSXZ2



3-Wire Wi-Fi Adapter
(AC Cloud Control)
FJ-RC-WIFI-1NA



p. 101

Converter/Adapter

For system expansion and 3rd-party controls

Network Converter
(DC power supply)
UTY-VTGX

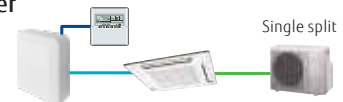

Network Converter
(AC power supply)
UTY-VGGXZ1



p. 102

Signal Amplifier
UTY-VSGXZ1



p. 102

External Switch Controller
UTY-TERX

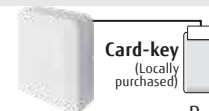

p. 103













3rd Party Thermostat Converter
UTY-TTRX



p. 104



Remotes & Controllers

		REMOTES				CONTROLLERS					WI-FI INTERFACE MODULES		
													
Model name		UTY-RNRUZ*	UTY-RSRY	UTY-RHRY	UTY-LNHU	UTY-DTGYZ1	UTY-DCGYZ2	UTY-DCGY	UTY-APGXZ1	UTY-ALGXZ1	UTY-TFSXZ2	FJ-AC-WIFI-1	FJ-RC-WIFI-1NA
Max. controllable remote control groups		1	1	1	1	400	100	100	1600	400	1	1	1
Max. controllable indoor units		16	16	16	16	400	100	100	1600	400	1	1	1
Max. controllable groups		—	—	—	16	100	16	16	1600	400	—	—	—
Air conditioning control function	On / Off	●*3	●	●	●	●	●	●	●	●	●	●	●
	Operation mode setting	●	●	—	●	●	●	●	●	●	●	●	●
	Fan speed setting	●	●	●	●	●	●	●	●	●	●	●	●
	Temp. setpoint setting	●	●	●	●	●	●	●	●	●	●	●	●
	Room temp. setpoint limitation	●	●	●	—	●	●	●	●	●	—	●	●
	Test operation	●	●	●	●	●	●	●	—	—	—	—	—
	Vert. Airflow Dir. / Swing setting	●	●	●	●	●	●	●	●	●	●	●	●
	Horiz. Airflow Dir. / Swing setting	●	—	—	●	●	●	●	●	●	●	●	●
	Individual louver control	●	—	—	—	●	—	—	—	—	—	—	—
	Group setting	—	—	—	—	●	●	●	●	●	—	—	—
	RC prohibition	—	—	—	—	●	●	●	●	●	—	—	—
	Anti freeze setting	—	—	—	—	●	●	●	●	●	—	—	—
	Set temp. auto return	●	—	—	—	—	—	—	—	—	—	—	—
	Away setting	●	—	—	—	—	—	—	—	—	—	—	—
Economy mode setting	●	—	—	●	●	●	●	●	●	●	—	—	
Occupancy/Human sensor setting	—	—	—	—	—	—	—	●	●	●	—	—	
Display	Error	●	●	●	—	●	●	●	●	●	●	●	●
	Defrosting	●	●	●	—	●	●	●	●	●	●	—	—
	Current time	●	—	—	●	●	●	●	●	●	—	—	—
	Day of week	●	—	—	—	●	—	—	●	—	—	—	—
	R.C. prohibition	●	●	●	—	●	●	●	●	●	●	—	—
	Cooling/heating priority	●	●	●	—	●	●	●	●	●	—	—	—
	Address display	●	●	●	—	●	●	●	●	●	—	—	—
	Room temp	●	●	●	—	—	—	—	—	—	●	●	●
	Multi language	●	—	—	—	●	●	●	●	●	●	●	●
	Daylight Saving Time setting (Summer)	●	—	—	—	●	●	●	●	●	—	—	—
	Time zone setting	—	—	—	—	●	—	—	—	—	●	●	●
	Name registration	●	—	—	—	●	●	●	●	●	●	●	●
	Backlight	●	●	●	—	●	●	●	—	—	—	—	—
	2D floor layout / 3D building display	—	—	—	—	—	—	—	●	—	—	—	—
Timer	Schedule timer	Period	Week	—	—	Year	Week	Week	Year	Year	Week	Year	Year
		On/Off, Temp, mode, times per day	8*3 *4	—	—	20	20	20	144	144	—	10	10
	On/off timer	—	—	—	●	—	—	—	—	—	—	—	—
	Sleep timer	—	—	—	●	—	—	—	—	—	—	—	—
	Program timer	—	—	—	●	—	—	—	—	—	—	—	—
	Auto off timer	●	—	—	—	—	—	—	—	—	—	—	—
Day off	●	—	—	—	●	●	●	●	●	—	—	—	
Min. unit of timer setting (Minutes)	10 · 30	—	—	5	10	10	10	10	10	—	—	—	
Control	Status monitoring system	—	—	—	—	●	●	●	●	●	—	—	—
	Electricity charge apportionment	—	—	—	—	—	—	—	●	○	—	—	—
	Error history	●	—	—	—	●	●	●	●	●	●	●	●
	Emergency stop	—	—	—	—	●*2	●*2	●*2	—	—	—	—	—
	Remote management	—	—	—	—	—	—	—	●	○	●	●	●
	Energy saving management	—	—	—	—	—	—	—	○	○	●	—	—
Low noise mode	—	—	—	—	●	—	—	—	—	●	—	—	
Internet	Email notification for malfunction	—	—	—	—	—	—	—	●	●	●*5	●*5	●*5
	Key lock	●	Child lock	—	—	●	●	●	●	●	●	●	●
Other BMS	Third party Modbus communication	—	—	—	—	—	—	—	○	○	—	—	—
	Service Tool Functionality	—	—	—	—	—	—	—	—	—	—	—	—

84 *1 "Operation mode" setting is not available for this model. *2 This function is available only through external input. control. *3 On / Off (Occupied / Unoccupied) *4 Mode deleted *5 Notification of errors, operating mode changes, and temperature alarms *6 Monitoring control functions similar to Service Tool ●: Supported ○: Optional function —: Not supported yet

Touch Panel Wired Remote Control

(2-wire): UTY-RNRUZ*

Max. controllable
16
indoor units

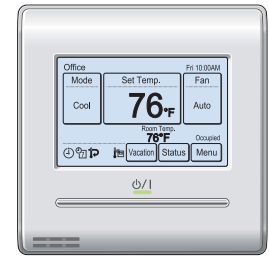

User friendly operation with high-definition large STN-LCD touch screen

- Built-in temperature sensor
- Built-in weekly/Daily timer (ON/OFF (Occupied/Unoccupied), Temp.)
- Backlight enables easy operation in a darkened room
- Room temperature display
- Temperature set point limitation
- Multi-language (English, Chinese, French, German, Spanish, Russian, Polish, Italian, Greek, Portuguese, Turkish and Dutch)

High performance and compact size

- Flexible remote controller with individual control mode and various energy saving controls functions.



Accurate and comfortable control

- Built in air temperature sensor for accurate control and display of indoor air temperature.

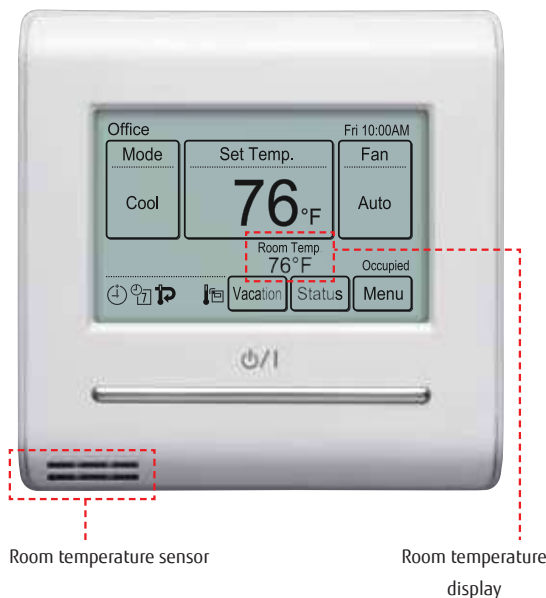

Various energy saving settings

Auto OFF Timer

- The indoor unit automatically turns off after a set time has passed.
- The time interval for which auto off works can be set.

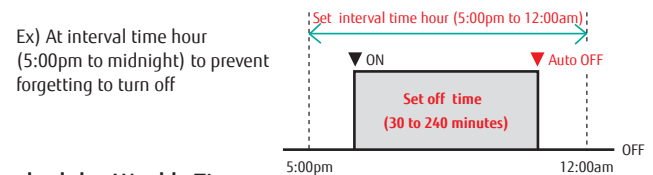

2 schedules Weekly Timer

- 2 schedules such as for the summer and winter can be set.
- 8 setting changeable per day of week (Setting items: ON / OFF (Occupied/Unoccupied), Temperature, Time)

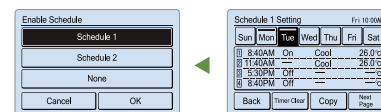

Schedule 1 (Summer schedule)

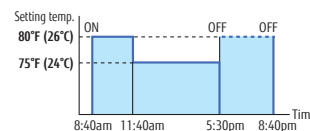

Schedule 2 (Winter schedule)

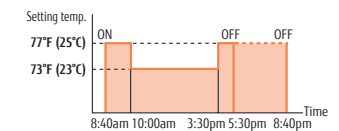

Optimum start function

- Provides configurable operation start to get the space to set temperature before scheduled time.

Cooling operation

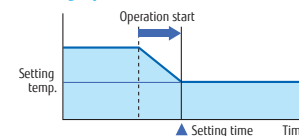

Heating operation

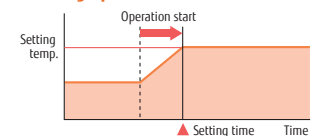

Set Temperature Auto Return

- The set temperature automatically returns to the previous setting.
- The time range in which the set temperature can be changed is 10 to 120 minutes.

Set Temperature Upper and Lower Limit Setting

- Set temperature range can be set for each operation mode. (Cooling / Heating / Auto)

Cooling operation

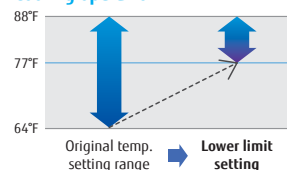

Heating operation

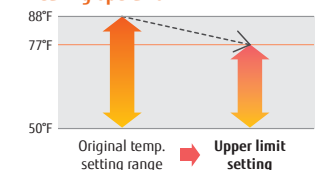

Backlight

- Backlight enables easy operation in a dark room.
- Choose to have the backlight display stay on for 30 or 60 seconds.

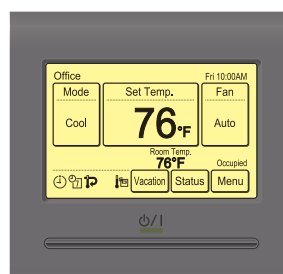

Touch Remote Control UTY-RNRUZ* (continued)

Additional functions

Away mode

- Cooling / Heating is automatically started when the room temperature reaches a setting temperature even if the indoor unit is off.

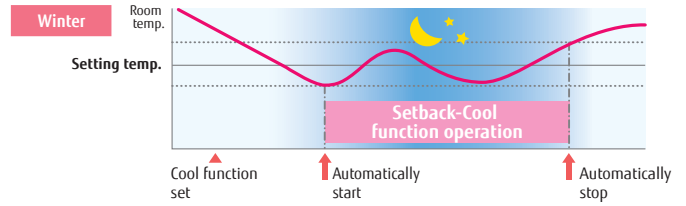
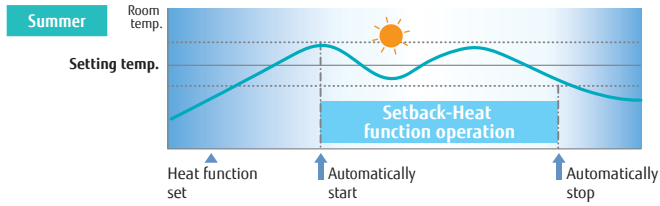

Displays setting status and limitations

- The remote controller settings can be easily checked

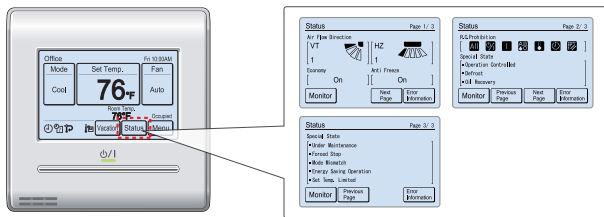

Child lock

- Lock / unlock method: Push the ON/OFF button on the screen (4 seconds)

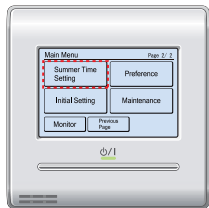

Daylight savings time (Summer Time)

- Provides Daylight Savings adjustment option.

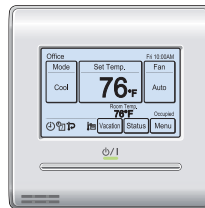

Name registration

- Easy identification of Indoor units using the user programmed names.

Monitor of EEV pulses from within the controller

Simplified installation

Easy to install using non-polar 2-wire communication cable

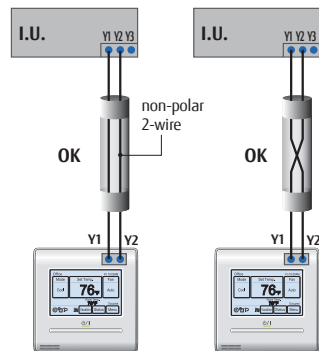

Auto Address Setting/Setting Position Notification

- Auto addressing for reliable and quick installation

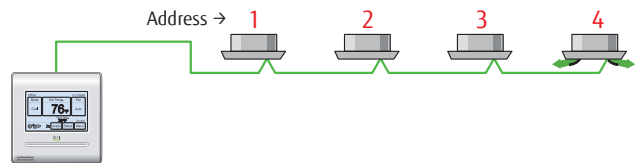

Easy Maintenance

Operation history saved in the controller



Specifications

Model name	UTY-RNRUZ*
Power source	DC 12V
Dimensions (H x W x D) (in. (mm))	4-3/4 x 4-3/4 x 11/16 (120 x 120 x 20.4)
Weight (oz.(g))	8 (220)

Simple Remote Control

(2-wire) UTY-RSRY / UTY-RHRY (Without operation mode)

(3-wire) UTY-RSKU / UTY-RHKU (Without operation mode)

Compact wired remote control unit provides access to basic functions

- Built-in temperature sensor
- Backlit display
- Simple functions make the controller perfect for hotels, schools, etc.

Max. controllable
16
indoor units

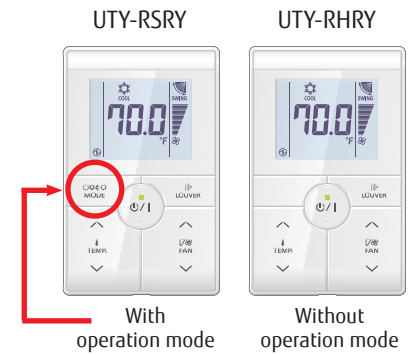

Room temperature set point limitation

Equipped with set point limitation option for energy efficiency.

Vertical louver control

Offers vertical louver control for ducted and cassette units.

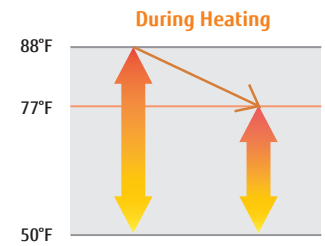
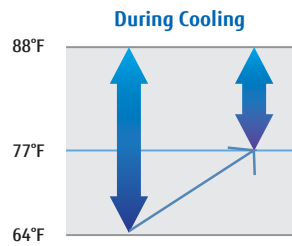
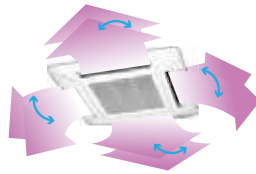
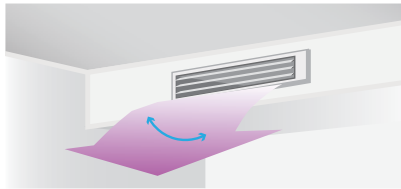

Specifications

Model name	UTY-RNKU	UTY-RSRY	UTY-RHRY
Power Supply	DC 12V	DC 12V	DC 12V
Dimensions (H x W x D) (in. (mm))	4-3/4 x 4-3/4 x 11/16 (120 x 120 x 18)	4-3/4 x 2-15/16 x 9/16 (120 x 75 x 14)	4-3/4 x 2-15/16 x 9/16 (120 x 75 x 14)
Weight (oz. (g))	6 (160)	4 (120)	4 (120)

DC12V is supplied by the indoor unit.

Wireless Remote Control

UTY-LNHU

Simple and sophisticated operations with a choice of 4 daily timers

- One remote can control up to 16 indoor units.

Accurate and comfortable

Select from 4 different timer programs: On / Off / Program / Sleep
Program timer: The program timer operates the ON and OFF timer once within a 24 hour period.

Sleep timer: The sleep timer function automatically corrects the set temperature according to the time setting to prevent excessive cooling or heating during sleep hours.

Easy installation and operation

- Code selector switch prevents indoor unit mix-up. (Up to 4 codes can be set.)
- Reliable transmitting over long range.
- IR Built-in receiver is standard in compact cassette, ceiling/floor, and wall mounted indoor units.

Max. controllable
16
indoor units

Selectable
4
daily timers

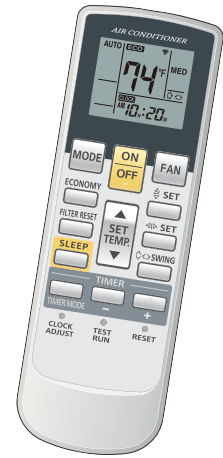

Address setting

During installation, address setting can easily be done using the Wireless Remote Control, thus eliminating manual setting inside the Indoor unit.

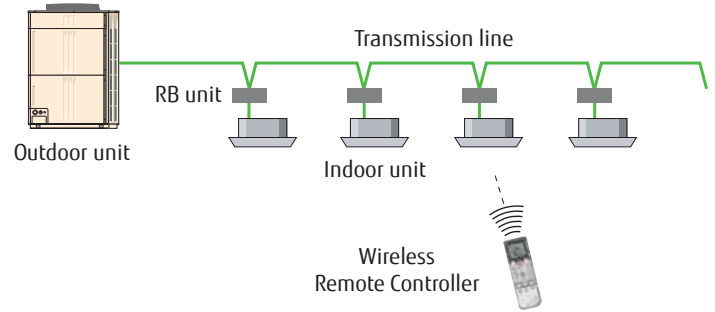

IR Receiver Unit: UTB-YWC (for VRF ducted models)

IR Receiver Unit: UTY-TRHX (for TLAV2 ducted models)

Required for controlling ducted indoor unit via a Wireless Remote Control

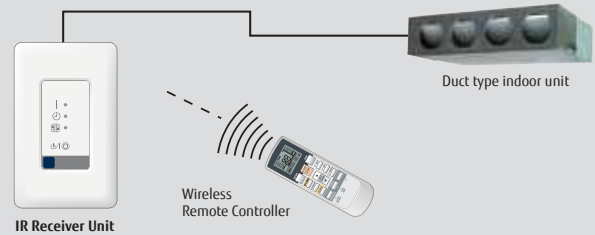

IR Receiver Unit: UTY-LRHYB1

Cassette type indoor unit can be controlled with Wireless Remote Control

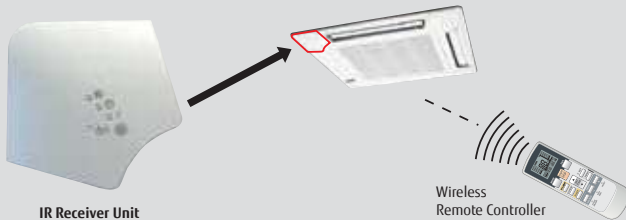

IR Receiver Unit: UTY-LBHxD

Circular Flow Cassette type indoor unit can be controlled with Wireless Remote Control.

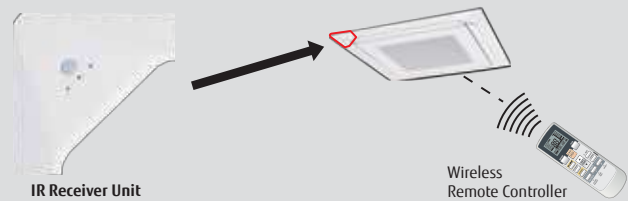

Touch Panel Controller with Internet

UTY-DTGYZ1

Max. controllable
400
indoor units



High visibility and easy operation via high resolution 7.5 inch TFT-LCD touch panel screen

- Controls up to 400 indoor units*
- Provides Internet/LAN remote control and operation
- Indoor units can be grouped for group monitoring and setting
- Schedules are programmable with up to 20 settings per day
- Easy-to-understand Graphical User Interface (GUI)
- Data can be transferred via USB for further analysis
- Mounts flush to the wall.
- Large-sized 7.5-inch no-glare TFT color touch screen
- Selectable 2 display types (Icon / List) in monitoring mode
- Supports 7 different languages, English, Chinese, French, German, Spanish, Russian, Polish.

* For Heat Recovery network systems the limit is 320 indoor units, consult the D&T manual for proper wiring and the use of signal amplifiers.

Functions



Easy maintenance

- Flat touch screen is easily cleaned
- Non-glare coating on touch panel controller minimizes fingerprints
- Easy-to-remove front cover



Remote Monitoring and Operation Functions

- Internet/LAN remote monitoring and control of the VRF system using a web browser. (Operation status monitoring, Operation mode setting, and error history display)
- Automatically emails operation status.

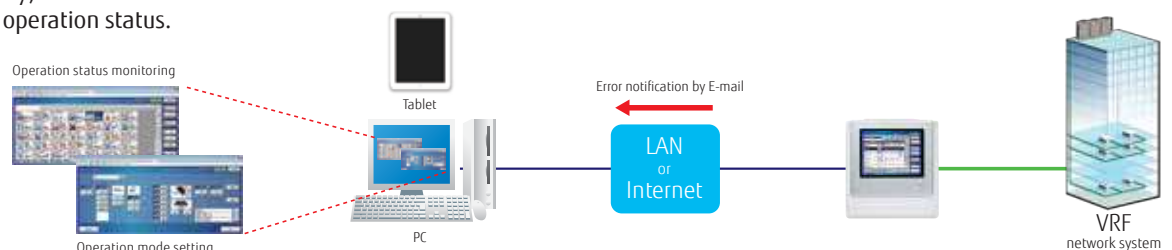

Easy operation

- Easy-to-understand icon-driven Graphical User Interface (GUI)



- Touch screen
- Up-to-date status display
- Background color identifies current control operation; blue for monitoring, green for operational control

Optional: Electricity charge apportionment

Electricity Charge Apportionment optional add-on USB drive can be added to enable building owners to apply sub-tenant billing.

Up to 400 indoor units can be controlled

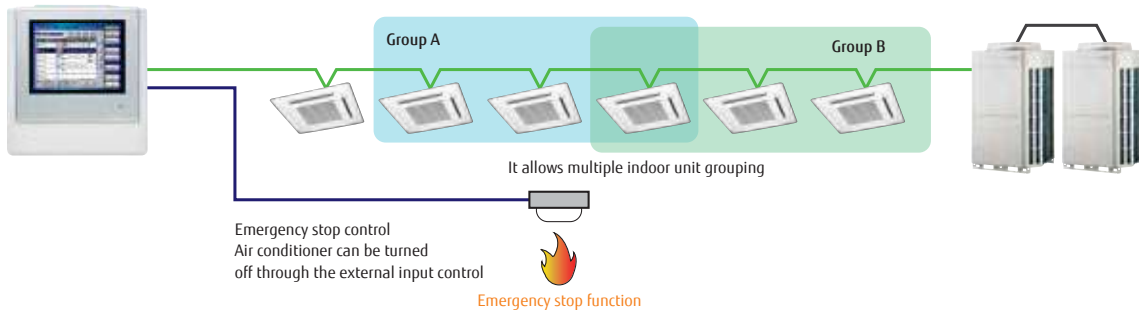

Function

- Up to 400 indoor units can be controlled
- Multiple indoor units can be grouped and controlled
- Schedule timer function is standard (20 patterns per day)
- Emergency stop function (through the external input control)
- Temperature upper and lower limit setting

Versatility

- Emergency stop function: Air conditioner can be turned off through the external input control
- Stored data can easily be transferred to USB port for further analysis.
- CSV format data can be imported to Touch Panel Controller.



Individual control



Flexible grouping



Schedule control



Indoor units operation monitoring

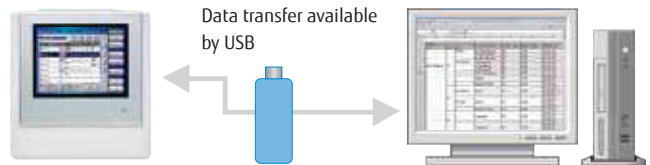

Easy installation

- No additional components are required for installation.



Automatic clock adjustment

The time setting of each remote control can be set in group automatically.

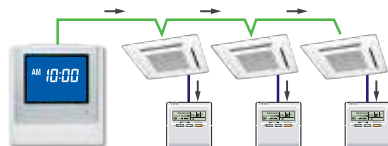

Specifications

Model name	UTY-DTGYZ1
Power Supply	100-240V 50/60Hz, Single phase
Dimensions (H x W x D) (in. (mm))	10-1/4 x 9-11/16 x 2-1/8 (260 x 246 x 54)
Weight (lbs.(g))	5 (2150)
Interface	Transmission / LAN / USB / EXT IN / EXT OUT / Reset SW

Central Remote Controller

UTY-DCGYZ2



For small- and medium-sized buildings

- Individual control and monitor of 100 indoor units and max. 50 groups
- 7.0inch TFT color screen for high visibility and easy operation
- Supports max.23 different languages
- 12 different languages. (English, Spanish, German, French, Italian, Russian, Portuguese, Turkish, Polish, Greek, Dutch, Chinese)
- Additional language can be integrated by creative language database. *(Bulgarian, Czech, Danish, Estonian, Finnish, Croatian, Hungarian, Romanian, Slovak, Slovenian, Swedish)

Easy operation

- Central remote controller with intuitive operation via touch panel operation
- All functions accessed from the top screen

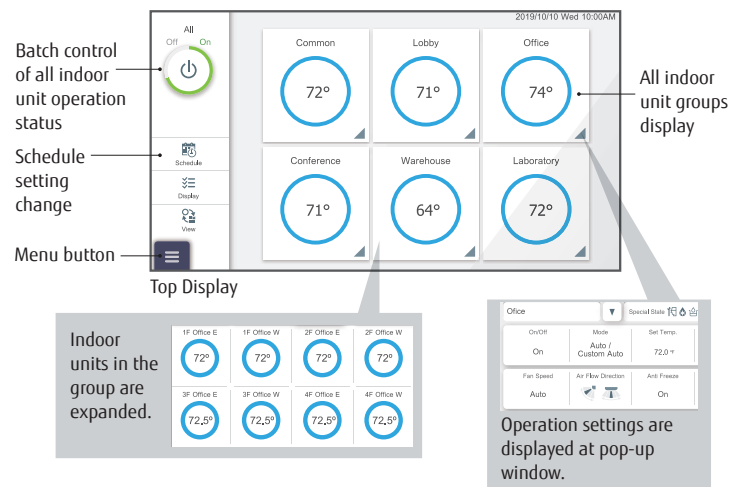

Trouble support function

- Displays operation status details and explanations

Sensor value monitoring function
Monitor sensor data of indoor unit / outdoor unit, send mail

Notify room temperature by email
Notify by email when the temperature around the air conditioner is out of defined range

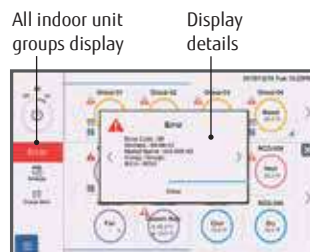

Remote monitoring / Remote operation

Central remote controller can control tenant's air conditioner anytime and anywhere.

Example

- Control / Monitoring Fujitsu air conditioner
- Operation status notification by email
- Access to group names

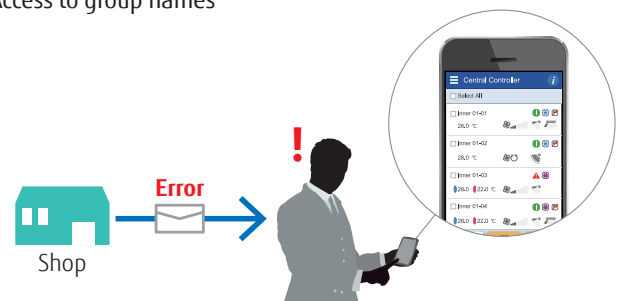

Specifications

Model name`	UTY-DCGYZ2
Power Supply	100-240 V 50/60 Hz
Dimensions (H x W x D) (in.(mm))	5-5/16 x 8-1/2 x 1-1/2 (134.6 x 216.1 x 37.9)
Weight (lbs. (g))	1-21/32 (750)

Central Controller

UTY-DCGY

Max. controllable
100
indoor units

Max. controllable
16
groups



Central Controller fits small- and medium-sized buildings

- Individual control and monitor of up to 100 indoor units
- 5 inch TFT color screen for user friendly view and easy operation
- External input / output contact
- Detachable power supply unit
- 7 different languages (English, Chinese, French, German, Spanish, Russian, Polish)

System overview

- Allows multiple indoor units grouping (Max.16 groups controlled)
- Possibility to interlock with external device

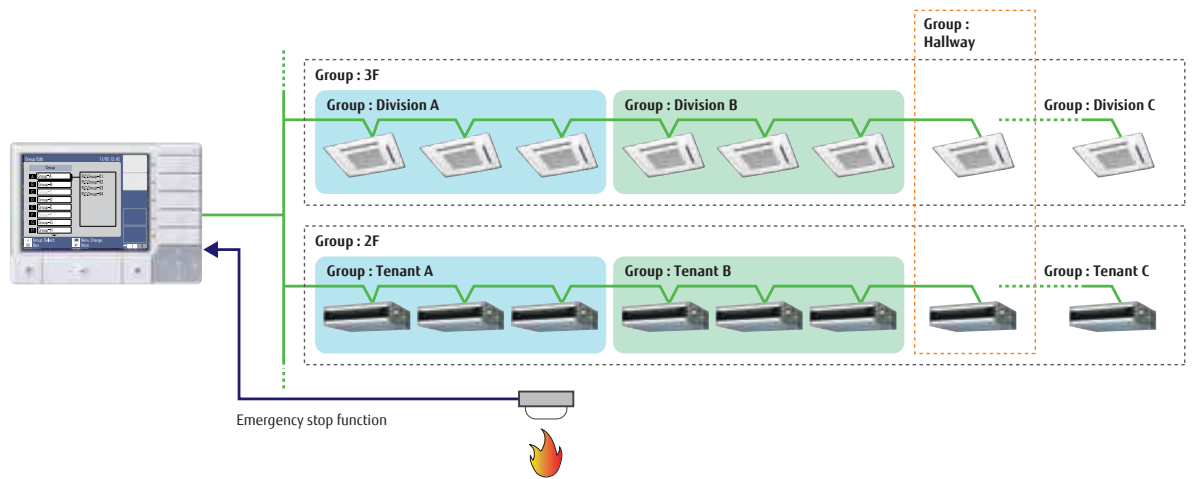

Easy Installation

- The control panel and power supply unit can be installed separately
- For flexibility in installation, the control panel can be built into the wall or flush mounted

Setting pattern 1

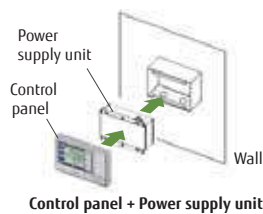

Setting pattern 2

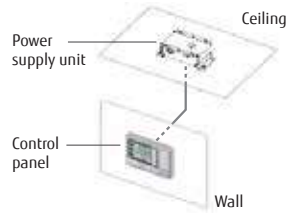

Functions

- Diverse control of indoor units
- Weekly timer
- Automatic clock adjustment
- Error history

Specifications

Model name	UTY-DCGY	
	Control Panel	Power Supply Unit
Power Supply	DC 5V	100-240V, 50-60Hz, Single phase
Dimensions (H x W x D) (in.(mm))	4-3/4 x 6-3/8 x 1 (120 x 162 x 25.7)	3-7/8 x 5-5/16 x 1-9/16 (99 x 135 x 39.2)
Weight (oz.(g))	11 (308)	13 (355)

Packing List

Control Panel / Power Supply Unit / Connecting cable, etc.

System Controller Software

UTY-APGXZ1

System Controller provides advanced integrated monitoring & control of VRF network system from small to large buildings

- Up to 4 VRF network systems, 1600 indoor units, and 400 outdoor units can be controlled.
- In addition to air conditioning precision control function, central remote control, electricity charge calculation, schedule management, and energy saving functions are available to meet different needs.



- Max. controllable
4
VRF network systems
- Max. controllable
400
outdoor units
- Max. controllable
1,600
indoor units

System Controller Lite Software

UTY-ALGXZ1

System Controller Lite is designed for small and medium size buildings

- Controls up to a maximum of 1 VRF network system, 400 indoor units, and 100 outdoor units.
- In addition to air conditioning precision control function, a variety of management software add-ons are available as options to meet customers needs.



- Max. controllable
1
VRF network system
- Max. controllable
100
outdoor units
- Max. controllable
400
indoor units

User friendly view and operation

- The building can be viewed and controlled in a 3D click-able perspective view: Four different views are available – site, building, floor, or list view.
- Flexibility to define groups for group control: Indoor units can be freely grouped for simple control from a BMS tree menu. Grouping by hierarchal structure, such as by section, division or department is possible.

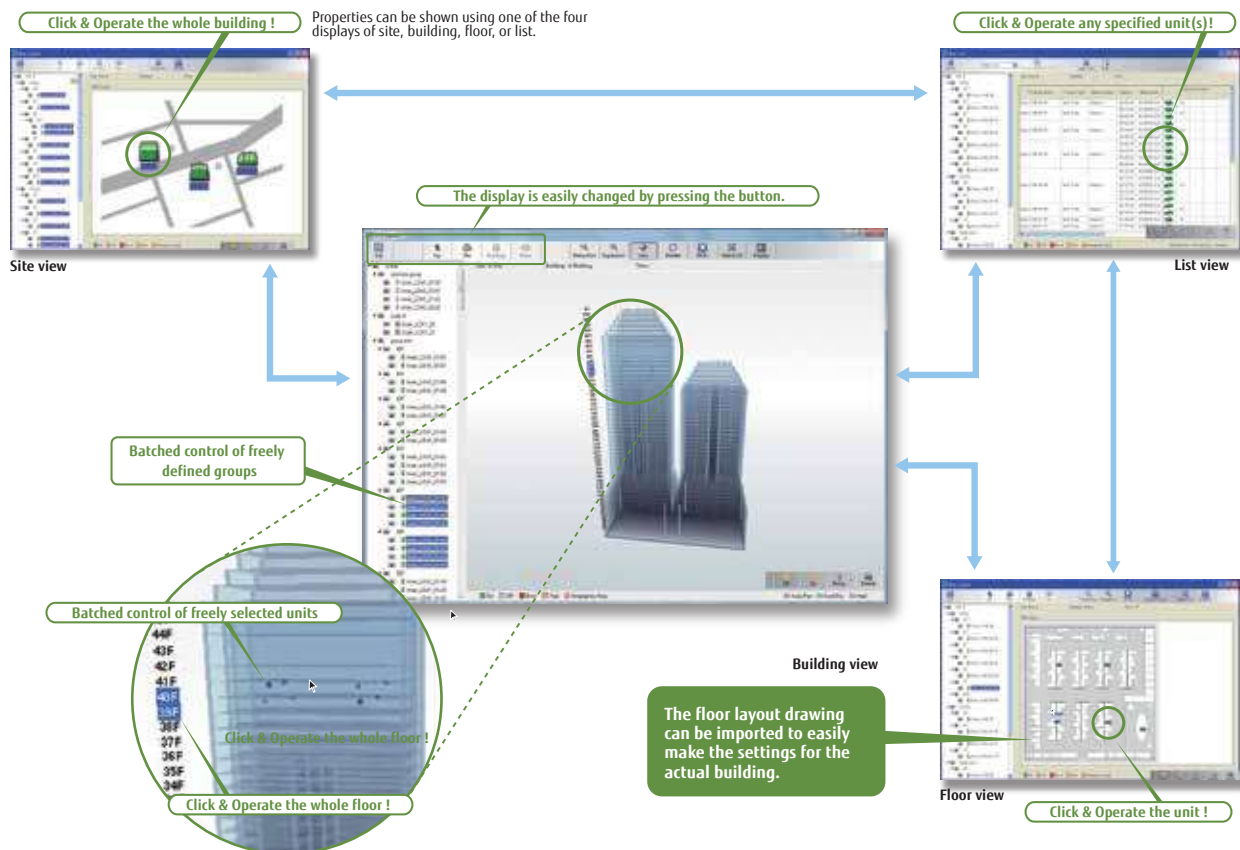

Note:
2D floor layout / 3D building display are not available for System Controller Lite.

Control of 3rd party devices via Modbus

When Modbus Adapter (locally purchased) is connected to system controller PC, the devices connected to the Modbus can be centrally controlled.

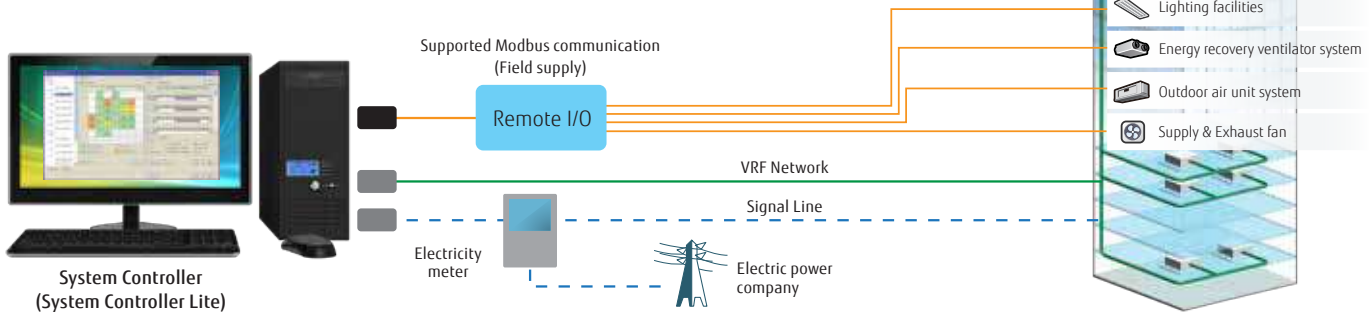

Operation management & Data management

Schedule management

- Annual schedules can be set for each remote control group / user defined group.
- Start / stop, operating mode, disabling of remote control, and temperature settings can be set up to 143 times per day at minimum 10 minute intervals for up to 101 configurations for each remote controller group.
- Allows programming of special settings for holidays, including public holidays, for a complete year.
- Low noise operation of outdoor unit can be scheduled.



Control of indoor unit

- Indoor unit operation state, operation mode, etc. are displayed
- Indoor unit start / stop and operation mode switching
- Room temperature set point limitation

Operation status display & email notification

Operation changes provide popup messages, audible sound and emails. Events for the past year are logged for later review.

Remote control block

This prohibits changes to the operation mode, temperature, start/stop, etc.

Database import/export

Imports/exports registration data, layout data, and image data. Only accessible by administrator.

Automatic clock adjustment

The time setting of each controller can be set in group automatically.

Operating & control record

Displays the history of operation status and control.

Electricity charge allocation

Allocation of monthly cost per tenant for HVAC. The Electricity Charge allocation function determines the share of the total utility bill for each of the tenants. See figure. The detailed calculation takes into consideration unused rooms, nighttime electricity charges, etc.

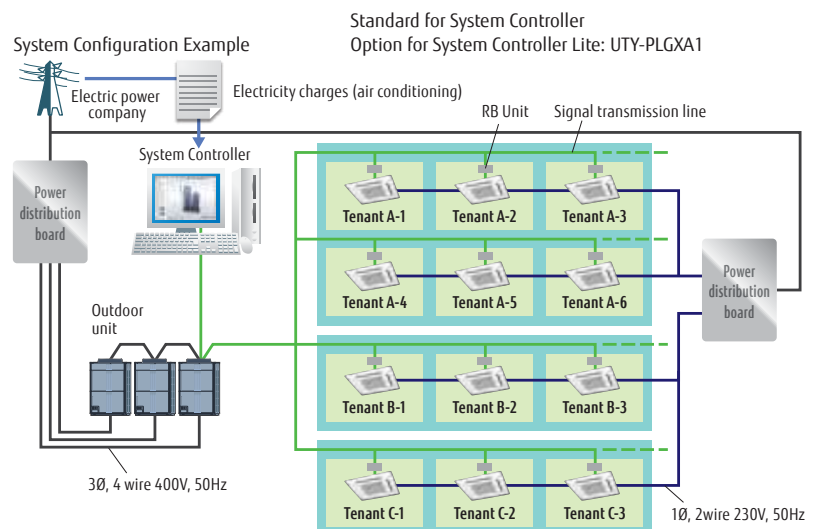

System Controller and System Controller Light (continued) Software

Remote management (Standard for System Controller: UTY-PEGXZ1, Option for System Controller Lite: UTY-PLGXR2)

System Controller may be used on site or remotely over various networks for remote central control. VRF Controller runs on site and communicates with VRF system. VRF Explorer runs remotely and provides user interface and communicates with the VRF Controller. VRF Controller and VRF Explorer programs may run on a single PC or on different PCs. By using VRF Explorer software, one PC can perform central control of 10 VRF system sites with max. 20 buildings per site.

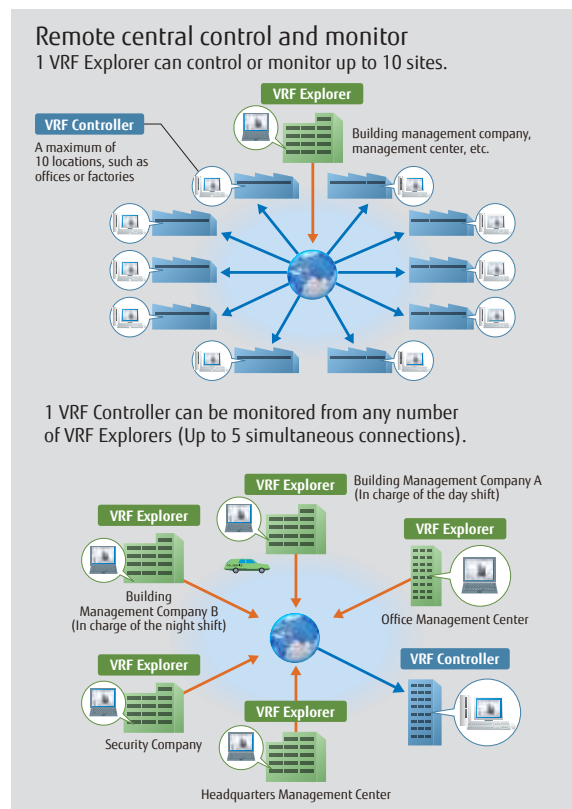
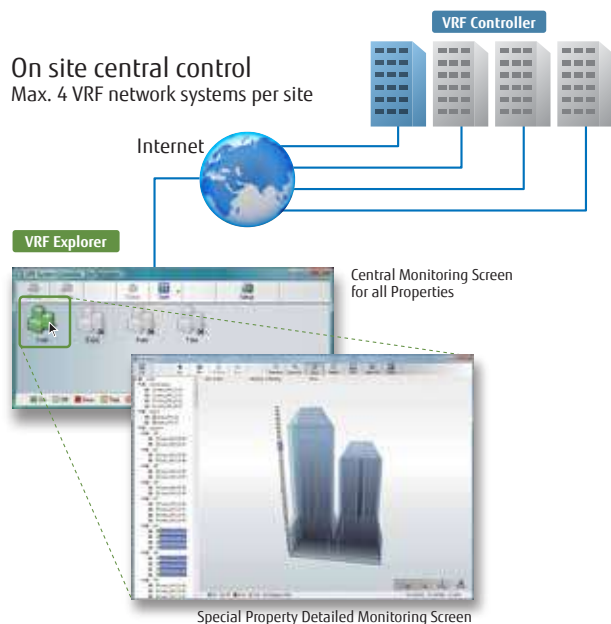

Below are additional options for System Controller: UTY-PEGXZ1 and System Controller Lite: UTY-PLGXR2

Energy saving management

A variety of energy saving operations can be set and managed depending on the season, weather, and time period. Excellent energy saving operation is performed while keeping users comfortable.

Energy saving graph data:
This graph compares the electricity consumption with the previous month and previous year to make it easy to analyze the energy saving effect.



Energy Saving Management Main Screen

Peak limit operation

To control power consumption and load shedding, the system can be programmed to change the indoor unit set temperature, turn the indoor unit thermostat off, or adjust other parameters to carefully control the amount of power consumed while maintaining comfort.

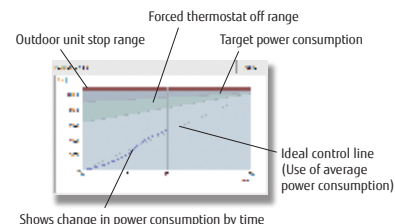

Indoor unit rotation operation

The operation of indoor units can be automatically rotated within a group in accordance with the set annual schedule to reduce power consumption while maintaining comfort.

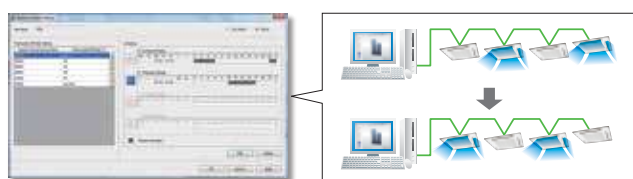

Outdoor Unit Capacity Save

The function 'Outdoor Unit Capacity Save', switches the outdoor unit capability upper limit to suppress power consumption during hot summers and cold winters by averaging the power saving effect of each refrigerant system. Function can be applied for 50% or more of the upper capacity limit.

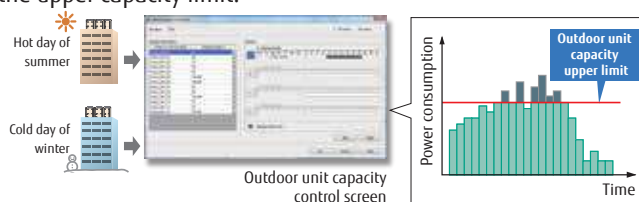

Functions summary

Function	Type	System controller		System controller lite				
		UTY-APGXZ1	Option UTY-PEGXZ1	UTY-ALGXZ1	Option UTY-PLGXR2	Option UTY-PLGXA2	Option UTY-PLGXE2	Option UTY-PLGXX2
System specification	Max. VRF networks supported	4	—	1	—	—	—	—
	Max. indoor unit / remote controller groups per VRF network	400	—	400	—	—	—	—
	Max. outdoor units per System controller	100	—	100	—	—	—	—
	Max. indoor units / remote controller groups per System controller	1600	—	400	—	—	—	—
Site supervision	Max. outdoor units per System controller	400	—	100	—	—	—	—
	Multi site display	10	—	10	—	—	—	—
	Number of building / 1 site	20	—	—	—	—	—	—
	Number of floor per 1 site	200	—	—	—	—	—	—
	Number of floor per 1 building	50	—	—	—	—	—	—
	3D graphical layout view	●	—	—	—	—	—	—
	2D graphical layout view	●	—	—	—	—	—	—
	List display	●	—	●	—	—	—	—
	Tree display	●	—	—	—	—	—	—
	Group display	●	—	●	—	—	—	—
Error management	Error notification	●	—	●	—	—	—	—
	Audible alarm	●	—	●	—	—	—	—
	Error email notification	●	—	●	—	—	—	—
History	Error history	●	—	●	—	—	—	—
	Operation history	●	—	●	—	—	—	—
	Control history	●	—	●	—	—	—	—
Operation control	Individual control	On/Off	●	—	●	—	—	—
		Operation mode	●	—	●	—	—	—
		Room temperature	●	—	●	—	—	—
		Fan speed	●	—	●	—	—	—
		Air flow direction	●	—	●	—	—	—
		Economy mode	●	—	●	—	—	—
		Room temperature set point limitation	●	—	●	—	—	—
		Test operation	●	—	●	—	—	—
		Antifreeze	●	—	●	—	—	—
		Outdoor unit low noise setting	●	—	●	—	—	—
	Individual management	Remote control prohibition setting	●	—	●	—	—	—
		Temperature upper and lower limit setting	●	—	●	—	—	—
		Filter sign reset	●	—	●	—	—	—
	Other	Memory operation	●	—	●	—	—	—
		Pattern operation	●	—	●	—	—	—
Schedule	Annual Schedule	●	—	●	—	—	—	
	Special day setting	●	—	●	—	—	—	
	On / off per day	72	—	72	—	—	—	
	On / off per week	504	—	504	—	—	—	
	Day off	●	—	●	—	—	—	
	Min. unit of timer setting (Minutes)	10	—	10	—	—	—	
	Low noise mode Weekly schedule	●	—	●	—	—	—	
Remote management	Remote monitoring	●	—	—	●	—	—	
	Remote operation control	●	—	—	●	—	—	
	Remote function setting	●	—	—	●	—	—	
	Web Remote Controller	●	—	—	●	—	—	
Electricity charge apportionment	Apportionment charge/bill calculation	●	—	—	●	—	—	
	Tenant (block) setting	●	—	—	●	—	—	
	Common facilities apportionment setting	●	—	—	●	—	—	
	Rated power consumption allotment setting	●	—	—	●	—	—	
	Individual calculation at cooling and heating	—	●*	—	—	●	—	
	Electricity meter supported	—	●	—	—	●	—	
Energy saving management	Indoor unit rotation	—	●	—	—	●	—	
	Peak cut control	—	●	—	—	●	—	
	Outdoor unit capacity save	—	●	—	—	●	—	
	Record of energy saving operation	—	●	—	—	●	—	
	Energy saving information	—	●	—	—	●	—	
	Power consumption monitor	—	●	—	—	●	—	
External Device Control	Monitor	●	—	—	—	—	●	
	Control	●	—	—	—	—	●	
Others	Database import/export	●	—	●	—	—	—	
	Automatic clock adjustment	●	—	●	—	—	—	
	Multi language	7 languages	—	7 languages	—	—	—	

● : Available. — : Not available.

*:Power calculation application software is necessary, please contact the local Fujitsu representative.

Computer system requirements:

Model name	System Controller	System Controller Lite
Operating system	<ul style="list-style-type: none"> Microsoft Windows 7 Home Premium (32-bit or 64-bit) SP1 Microsoft Windows 8.1 (32-bit or 64-bit) Microsoft Windows 10 Home (32-bit or 64-bit) 	<ul style="list-style-type: none"> Microsoft Windows 7 Professional (32-bit or 64-bit) SP1 Microsoft Windows 8.1 Pro (32-bit or 64-bit) Microsoft Windows 10 Pro (32-bit or 64-bit)
CPU	Intel® Core™ i3 2 GHz or higher	
Memory	• 2 GB or more (for Windows Vista® and Windows® 7 [32-bit])	• 4 GB or more (for Windows® 7 [64-bit], Windows® 8.1, and Windows® 10)
HDD	40 GB or more of free space	
Display	1024 x 768 or higher resolution	
Interface	<ul style="list-style-type: none"> Ethernet port (for getting access to the Internet using LAN) or Modem (for getting access to the Internet using public telephone line) USB ports (Maximum of 5 ports) (Required only for the server PC that works as VRF controller) – Maximum of 1 USB ports are required for WHITE-USB-KEY connection – Maximum of 4 USB ports are required for Echelon U10 USB Network Interface NOTE: Maximum number of required USB ports depends on the applicable system configuration. 	<ul style="list-style-type: none"> Ethernet port (for getting access to the Internet using LAN) or Modem (for getting access to the Internet using public telephone line) USB ports (Maximum of 2 ports) (Required only for the server PC that works as VRF controller) – 1 USB port is required for WHITE-USB-KEY connection – 1 USB port is required for Echelon U10 USB Network Interface NOTE: Maximum number of required USB ports depends on the applicable system configuration.
Graphic accelerator	Microsoft® DirectX® 9.0c compatible	
Software	Adobe® Reader® 9.0 or later	

• Personal computer that satisfies the following system requirements

• Echelon® U10 USB Network Interface – TP/FT-10 Channel (Model number: 75010R) (Required for each VRF network)

Packing list	For System controller			For System controller Lite			
	System controller	Option Energy manager	System Controller Lite	Remote access	Electricity charge apportionment	Energy saving	Central Control
Model name	UTY-APGXZ1	UTY-PEGXZ1	UTY-ALGXZ1	UTY-PLGXR2	UTY-PLGXA2	UTY-PLGXE2	UTY-PLGXX2
WHITE-USB-KEY	1	1	1	1	1	1	1

Software protection key to be inserted in a USB slot running System Controller or System Controller Lite.

System Controller or System Controller Lite may only run on a PC with WHITE-USB-KEY. However, WHITE-USB-KEY is not required for remote VRF Explorer software.

Airstage Integration Manager™

powered by
niagara
 framework®

FUJ-VRF-8025

FUJ-VRF-8125



Bundle includes: JACE 8000, Lon adapter, VRF driver for up to 25 or 125 total ODU + IDU, power adapter, 5 years software maintenance

Fujitsu is proud to announce an all-new hardware platform optimized for the Niagara Framework by Tridium Inc. – the Airstage Integration Manager™ (powered by Niagara). This “next-generation” controller is a dramatic evolution in integrating Airstage systems worldwide, featuring a new global design that functions with legacy systems and has the ability to scale for future needs.

The Airstage Integration Manager™ (powered by Niagara) is a compact controller and integration platform for connecting Airstage equipment and devices to any commercial Building Management System (BMS). The Airstage Integration Manager controller not only provides seamless BMS integration, it includes a guided configuration tool, basic monitoring and control functions, an alarm console, and cloud-based access (through a standard web browser via Ethernet or wireless LAN, or remote over the internet).

The licensing model for the Airstage Integration Manager controller is simple, and features native Airstage and standard open-protocol drivers, including BACnet, LonWorks, and Modbus. Optional IO and field bus expansion modules provide ultimate flexibility and expandability. The Airstage Integration Manager controller operates with Niagara 4, the latest version of the Niagara Framework, for optimum performance. In larger facilities, multi-building applications and large-scale control system integrations, Niagara 4 Supervisors can be used with Airstage Integration Manager controllers to aggregate information, including alarms and historical and real-time data, to create a single unified application.

System Diagram:

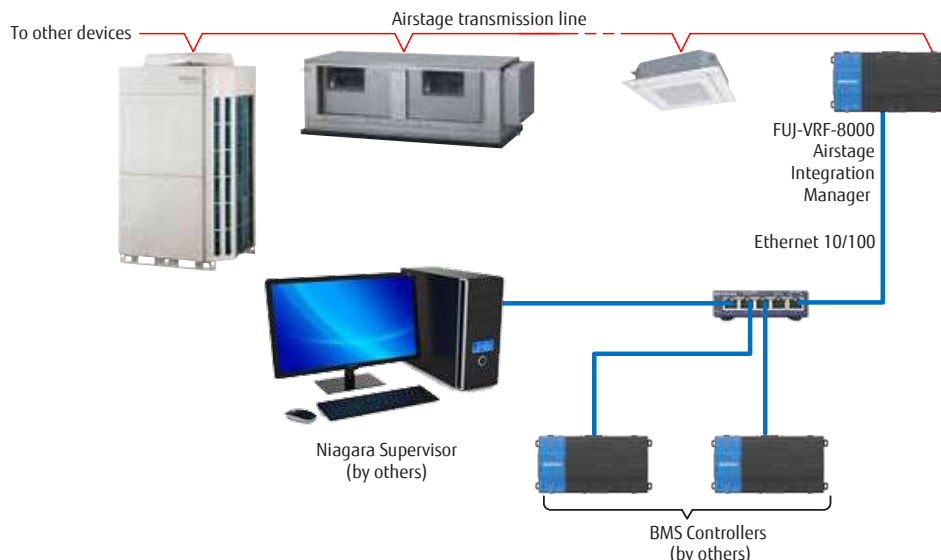

Efficient Global Design

The new, modular design of the Airstage Integration Manager controller makes it easy to install, integrate and deploy. Tool-less installation with expansion capability reduces installation complexity and improves flexibility. Systems integrators can focus on engineering solutions, not assembling components.

Key Features

Intuitive User Interface - Configuration and control software is custom-designed for Airstage systems. No experience with the Niagara platform is necessary. Users can easily check system status by glancing at the front panel LEDs to diagnose network issues.

Global Capacity Licensing and Upgrade Capability - The controller is purchased pre-licensed for 25 or 125 Airstage devices (indoor + outdoor units). Device license upgrades, in increments of 50, can be purchased in the future as your needs grow.

Modular Design For Easy Installation And Expansion - The LonWorks® module for Airstage connection is included. Up to 4 option modules directly attach to the controller for on board IO or additional communications ports, including types for LonWorks®, RS232 and RS485 networks. Controller and option modules are designed for easy mounting on a 35mm-wide DIN rail.

Global Power Compatibility - 24VAC or 24VDC power source. 120/24V power supply with adapter plugs included.

5-year Software Maintenance Agreement Included - Your Niagara software is protected with free updates to the latest Niagara versions. No need to worry about security patches or compatibility with other Niagara devices.

Hardware specifications

TI AM3352: 1000MHz ARM® Cortex™-A8

1GB DDR3 SDRAM

Removable micro-SD card with 4GB flash total storage/2GB user storage

USB type A connector

Back-up and restore support

(2) isolated RS-485 with selectable bias and termination

(1) LonWorks FTT-10A expansion module included (for connection to Airstage transmission line)

(2) 10/100MB Ethernet ports

Secure boot

Supply requirements: 24VAC rated at 24VA minimum, or 24VDC rated at 1A (24W) minimum; a 120/24V wall adapter is included

Runs Niagara 4: 4.9

Real-time clock

Batteryless

Niagara Analytics 2.1 is compatible with Niagara 4.4 and 4.6

Real-time clock

JACE® 8000 controller Mounting & Dimensions

- 1 JACE 8000 controller. Allow at least 1.5" (38mm) clearance around all sides
- 2 Expansion module. Up to four (4) may be used. See "Expansion Module and IO Configurations"
- 3 Distances between center of tabs from one unit to another unit

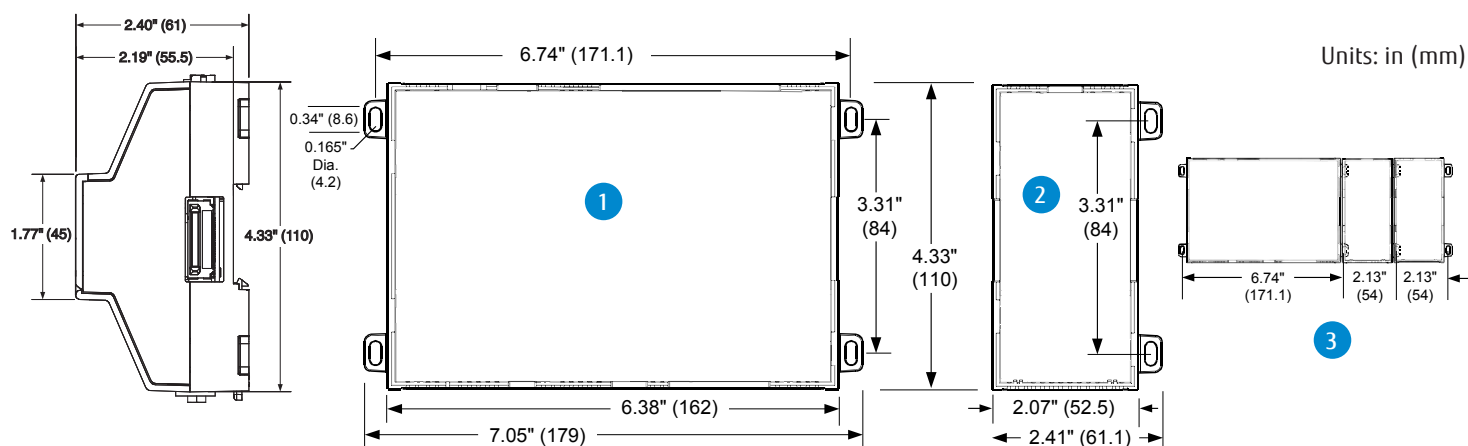

Compatible with (DIN43880) enclosures

Suitable for mounting to a panel or to an EN50022 standard 35mm rail

VRF	Compatible models	V-II / VR-II/ J-IVS / J-IV / J-IIIL
	Max. number of units	up to 125 OU+IU per JACE
	Max. number of VRF networks	1 per Lon adapter, up to 4 Lon adapters per JACE, depends on the license used
	Interface	JACE 8000: Lon adapter PC: Ethernet 10/100Mb port
Niagara	Version	Niagara 4.9
	Max. Points	about 20,000, depends on the license used



BACnet® Gateway (Hardware)

UTY-VBGX

Max. controllable
1
VRF network system

Max. controllable
32
outdoor units

Max. controllable
128
indoor units

BACnet® Gateway connects a VRF system to a BMS via BACnet® IP.

- A maximum of 128 indoor units and 32 refrigerant systems can be connected to a single BACnet® Gateway.
- Compatible with BACnet® (ANSI / ASHRAE-135-2012) application specific controller (B-ASC).
- Compatible with BACnet®/IP over Ethernet.

Installation example

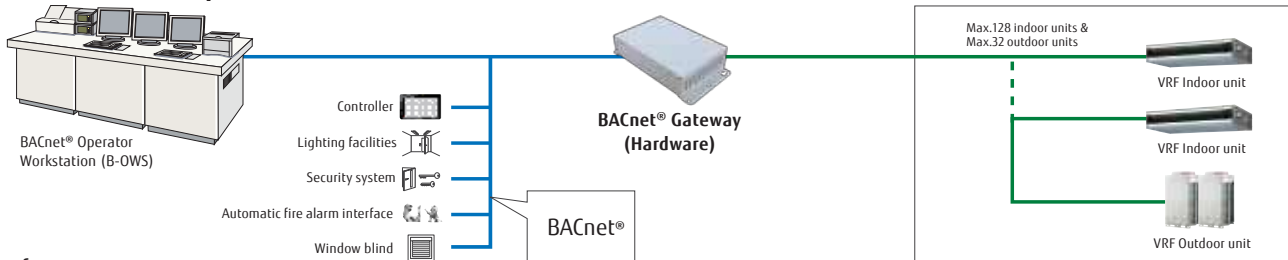

Specifications:

Model name	UTY-VBGX
Number of controllable indoor units	128
Number of controllable refrigerant system	32
Number of controllable VRF networks	1
Number of connectable Gateways / one VRF network	4

Model name	UTY-VBGX
Power supply	208-240V 50/60Hz, single phase
Input power (W)	4
Dimensions (H x W x D) (in.(mm))	10-1/4 x 2-5/16 x 5-11/16 (260 x 59 x 145)
Weight (lbs.oz.(g))	39oz (6100)

BACnet® Gateway

UTY-ABGXZ1 Software

Max. controllable
4
VRF network systems

Max. controllable
400
outdoor units

Max. controllable
1600
indoor units



Connect VRF network system to BMS via BACnet IP, a global standard for open networks.

- Up to 1600 indoor units with 4 VRF network systems (a maximum of 400 indoor units & 100 outdoor units for one network system) can be connected to one BACnet® Gateway.
- Compatible with BACnet® (ANSI / ASHRAE-135-2012) application specific controller (B-ASC).
- Compatible with BACnet®/IP over Ethernet.
- Scheduling function, Alarm & Event functions as well as as Electricity Charge allocation function is provided in BACnet® Gateway.
- Connection between VRF network system to personal computer is possible via small U10 USB interface. However, both U10 USB interface & personal computer are field supplied items.
- Corresponds to 7 different languages, English, Chinese, French, German, Spanish, Russian, Polish.

Personal computer system requirements:

Model name	UTY-ABGXZ1
Operating system	<ul style="list-style-type: none"> • Microsoft® Windows® 7 Home Premium (32-bit or 64-bit) SP1, Windows® 7 Professional (32-bit or 64-bit) SP1 • Microsoft® Windows® 8.1 (32-bit or 64-bit), Windows® 8.1 Pro (32-bit or 64-bit) • Microsoft® Windows® 10 Home (32-bit or 64-bit), Windows® 10 Pro (32-bit or 64-bit) Supported languages: English, Chinese, French, German, Russian, Spanish, and Polish
CPU	Intel® Core™ i3 2 GHz or higher
Memory	<ul style="list-style-type: none"> • 2 GB or more (for Windows® 7 [32-bit]) • 4 GB or more (for Windows® 7 [64-bit], Windows® 8.1 and Windows®10)
HDD	40 GB or more of free space
Display	1024 x 768 or higher resolution
Interface	<ul style="list-style-type: none"> • Ethernet port (for getting access to the Internet using LAN) • USB ports (Maximum of 5 ports) <ul style="list-style-type: none"> - 1 USB port is required for WHITE-USB-KEY connection - Maximum of 4 USB ports are required for Echelon® U10 USB Network Interface * Maximum number of required USB ports depends on the applicable system configurations.
Software	Adobe® Reader® 9.0 or later
Optical drive	DVD-ROM drive

Network Converter for LONWORKS®

UTY-VLGX

Connects VRF network system to a BMS network via LONWORKS® open network.

- Easy-to-use PC-based configuration software
- The UTY-VLGX enables central monitoring and control of a VRF network system from a BMS through a LONWORKS® FTT-10A interface.
- Up to 128 Indoor units can be connected to one Network Converter for LONWORKS®

Control up to **4** units to one BMS

Max. controllable **100** outdoor units

Control up to **100** outdoor units



Installation example

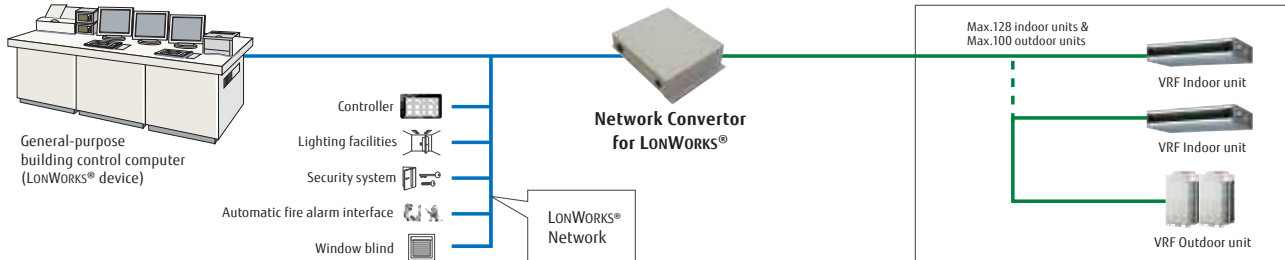

Specifications

Model name	UTY-VLGX
Power Supply	208-240V 50/60Hz, Single phase
Input power (W)	4.5
Dimensions (H x W x D) (in.(mm))	2-5/8 x 11-5/16 x 8-5/16 (67 x 288 x 211)
Weight (lbs.oz.(g))	3lbs. (1,500)

Transmission specifications (BMS side)

Transmission speed	78 kbps
Transceiver	FT-X1 (Echelon® Corporation)
Transmission way form	Free topology
Terminal resistor	None (It attaches at the terminal of a network.)

MODBUS® Converter

UTY-VMGX

UTY-VMGU-KIT

VRF System can be integrated with a building management system supported by MODBUS® RTU

Control up to **9** units to one BMS

Control up to **100** outdoor units

Control up to **128** indoor units



Installation example

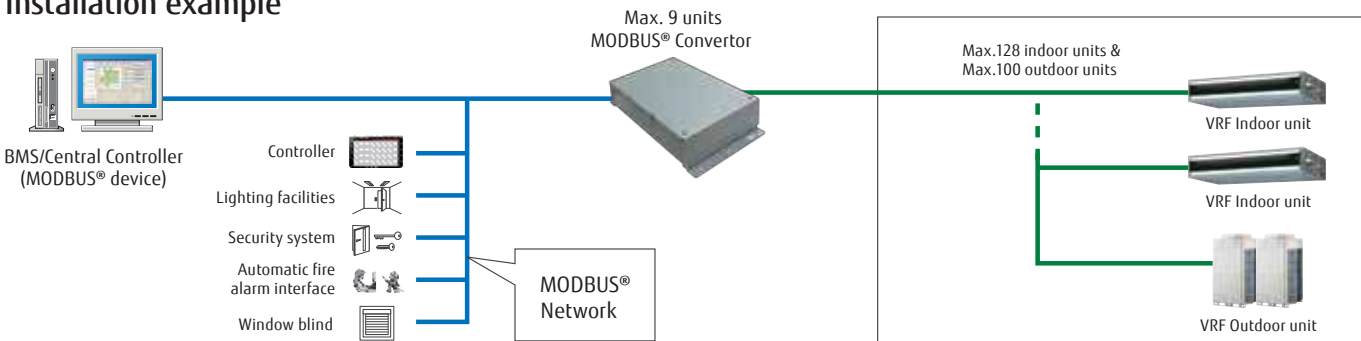

Specifications

Model name	UTY-VMGX
Power Supply	AC220/240V 50/60Hz AC208/230V 60Hz
Input power (W)	Max. 3
Dimensions (H x W x D) (in.(mm))	9-1/4 x 4-3/4 x 1-3/4 (235 x 120 x 45)
Weight (lbs.oz.(g))	39 oz. (1,100)

UTY-VMGX-kit Required when using SBC100.



Wi-Fi Interface Modules

UTY-TFSXZ2
(for indoor units with UART port) uses FGLair app

FJ-AC-WIFI-1
(for indoor units with UART port) uses AC Cloud Control App

FJ-RC-WIFI-1NA
(for 3-wire indoor units) uses AC Cloud Control App



For: Cassettes, Ducted Units, Ceiling Mount, Floor/Ceiling Mount (Universal), Wall Mounted, Floor Mount Units

Control your Fujitsu Airstage VRF indoor unit from anywhere over Wi-Fi, using a smartphone, tablet or PC[^] via the Internet.

How does it work?

- The indoor units are controlled from an intuitive, user-friendly interface.
- A wired device installed near each unit controls its operation and communicates over Wi-fi to the Internet router.
- A server in the cloud manages the whole process.

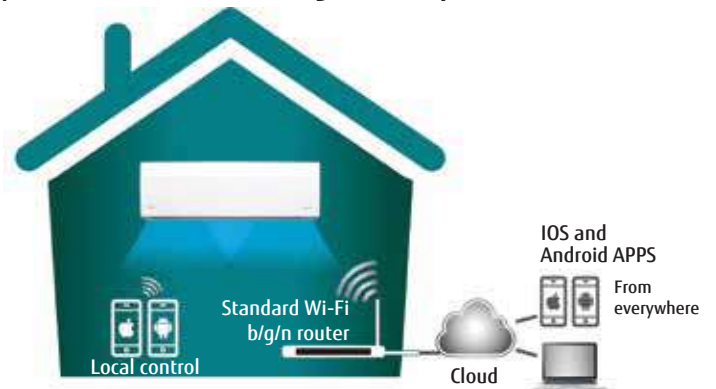

Features

- Manages the VRF indoor unit using the iOS or Android app.
- Programming of the indoor unit operation schedule.
- Offers access to several indoor unit settings including Mode, Temperature Set Point, Fan Speed, and much more.
- Room Temperature Display.
- Offers early startup function to bring the space to desired set point prior to being occupied.
- Offers delayed setback after leaving.
- Provides instant alarm notifications.
- Operation status reporting, available in several languages



Compatibility for Wired Wi-Fi Module

Type	UTY-TFSXZ2	FJ-AC-WIFI-1	FJ-RC-WIFI-1NA	Required Parts
	Indoor Unit Model	Indoor Unit Model	Indoor Unit Model	
Compact Wall Mounted (ASUA)	4, 7, 9, 12, 14TLAV1	4, 7, 9, 12, 14TLAV1	7, 9, 12, 14RLAV	Plug model: K9707476019*
	30, 36TLAV2	30, 36TLAV2	7, 9, 12, 14TLAV	
Wall Mounted (ASUB)	30, 36TLAV1	30, 36TLAV1	18, 24RLAV	Plug model: K9709223017*
			18, 24TLAV, 24TLAV1	
Compact Cassette (AUUA)	4, 7, 9, 12, 14, 18, 24TLAV2	4, 7, 9, 12, 14, 18, 24TLAV2	7, 9, 12, 14, 18, 24RLAV	Built-in Low voltage terminal block
			7, 9, 12, 14, 18, 24TLAV, 4TLAV1	
Cassette (AUUB)	18, 24, 30, 36, 48TLAV1	18, 24, 30, 36, 48TLAV1	18, 24, 30, 36RLAV	
			18, 24, 30, 36TLAV	
Floor Mount (AGUA)	4, 7, 9, 12, 14TLAV1	4, 7, 9, 12, 14TLAV1	--	
Floor/Ceiling (ABUA)	12, 14, 18, 24TLAV2	12, 14, 18, 24TLAV2	12, 14, 18, 24RLAV	
			12, 14, 18, 24TLAV	
Ceiling (ABUA)	30, 36TLAV2	30, 36TLAV2	30, 36RLAV	
			30, 36TLAV	
Slim Duct (ARUL)	7, 9, 12, 14, 18TLAV2	7, 9, 12, 14, 18TLAV2	7, 9, 12, 14, 18RLAV	
			7, 9, 12, 14, 18TLAV, 4TLAV1 (mini duct)	
Medium Static Pressure Duct (ARUM)	24, 30, 36TLAV2	24, 30, 36TLAV2	24, 30, 36RLAV	
			24, 30, 36TLAV	
High Static Pressure Duct (ARUH)	72, 96TLAV2	72, 96TLAV2	36, 48, 60RLAV	
			36, 48, 60, 72, 96TLAV	
Vertical Air Handler (ARUV)	--	--	12, 18, 24, 30, 36, 48, 60TLAV	
Technical Features	See product Submittals for specific information			

*Plug included with indoor wall mount units

Network Converters

UTY-VTGX (DC power supply)

UTY-VGGXZ1 (AC power supply)

Network Converters add Fujitsu mini-split control to the VRF communication network

Max. controllable
16
single indoor units

Max. controllable
100
Network Converters



UTY-VTGX
DC power supply



UTY-VGGXZ1
AC power supply

Installation example

- The converters are required when connecting single split units to the VRF communication network system. Both VRF system and single splits can be managed using the VRF central controller.
- See Network Converter submittal for Halcyon indoor unit model compatibility.

Single split with VRF

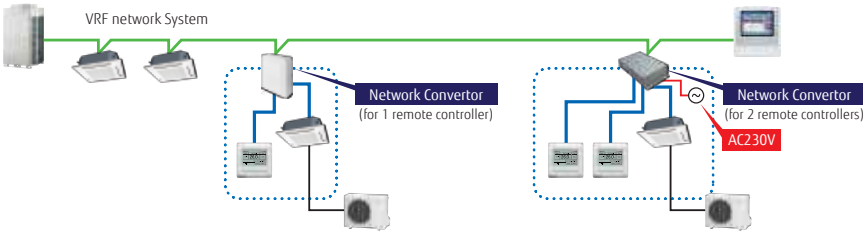

Specifications

Model name	UTY-VTGX		UY-VGGXZ1
Power Supply	polar 3-wire DC12V	non-polar 2-wire DC12V	220-240 V 50/60 Hz
Input power (W)	Max. 2		Max. 3
Dimensions (H x W x D) (in.(mm))	4-5/8 x 5-1/2 x 1-9/16 (117 x 140 x 40)		2 x 10 x 6 (54 x 260 x 150)
Weight (oz.(g))	9 (250)		38.8 (1,100)

Signal Amplifier

UTY-VSGXZ1

- Communication Line length can be extended up to 11,811ft. (3,600m) with multiple Signal Amplifiers.
- Up to 8 signal amplifiers can be installed in a single VRF communication network system.
- A signal amplifier is required
 1. When the total wiring length of the communication line exceeds 1,640ft. (500m).
 2. When the total number of units on the communication line exceeds 64.



Installation example

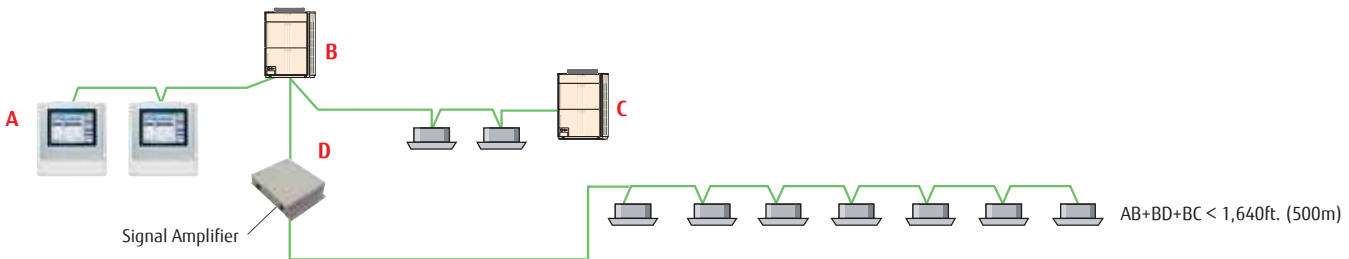

Specifications

Model name	UTY-VSGXZ1
Power Supply	208-240V 50/60Hz, Single phase
Input power (W)	4.5
Dimensions (H x W x D) (in.(mm))	2-5/8 x 11-5/6 x 8-5/16 (67 x 288 x 211)
Weight (lbs.oz.(g))	3lbs. (1,500)

External Switch Controller

UTY-TERX



Air conditioner operation can be controlled by connecting external sensor switches

- Very suitable for hotel rooms and similar. Input from external devices such as card-keys, temperature sensors, occupancy sensors, etc. can be used to control ON/OFF, Room temperature, Fan speed and other Master control functions.

Flexibility with possibility to set different temperatures for cooling and heating

Occupancy sensors can be used to setback temperature and fan speed when room is unoccupied. These setbacks are reverted when room becomes occupied again.

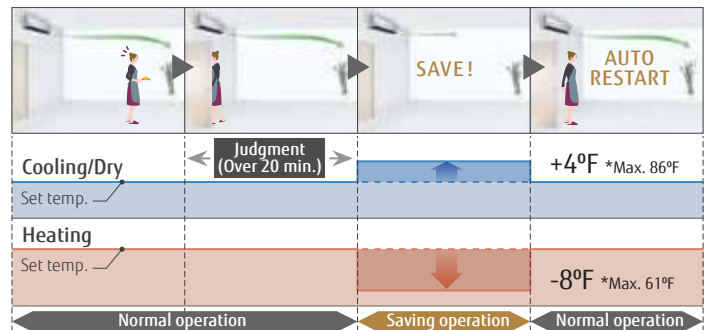

Functions

On/Off	•
Off	•
Room temperature setting	•

Fan speed setting	•
Operation mode setting	•
Prohibition setting	•

System overview

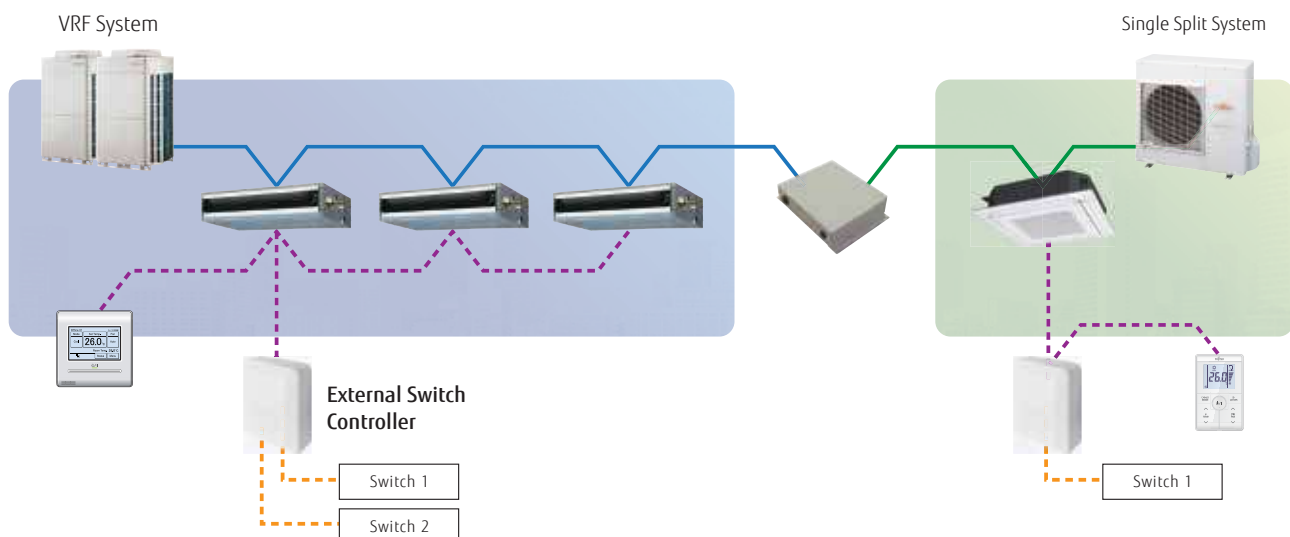

Specifications

Model name	UTY-TERX
Power Supply	DC6.5 - 16V
Dimensions (H x W x D) (in. (mm))	1-11/16 x 5-1/2 x 4-5/8 (43 x 140 x 117)
Weight (lbs.oz. (g))	9 oz. (250)

DC12V is supplied by the indoor unit.

3rd Party Thermostat Interface

UTY-TTRX, TTRX-KIT

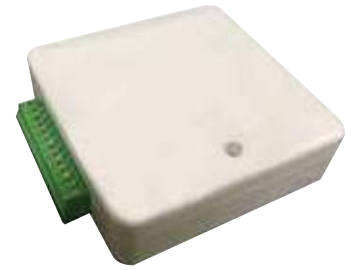

The Thermostat Interface enables 3rd party conventional or smart thermostats to be used in the Airstage VRF system

TTRX-KIT

Includes the most commonly used parts needed to install a UTY-TTRX Third Party Thermostat Interface. TTRX-KIT Includes:

- (1) UTY-TTRX Third Party Thermostat Interface
- (1) VPL24-210V Transformer
- (1) UTY-WiFi Plug

UTY-TTRX Functions

Unit Control Features	ON/OFF
	Temperature Setpoint (from 3rd party thermostat)
	One- or Two-stage Heating/Cooling
	Heating/Cooling Response Adjustment
	Delay OFF Adjustment
Service/Maintenance	Fan Speed
	Error notification via LED lights

Example

• Serial Communication • Remote control line • Thermostat Wire • VRF Network (Lon Works)

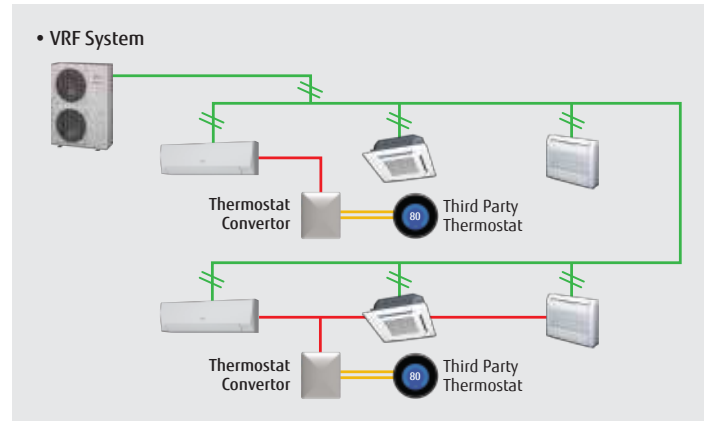

Maximum Wire Lengths

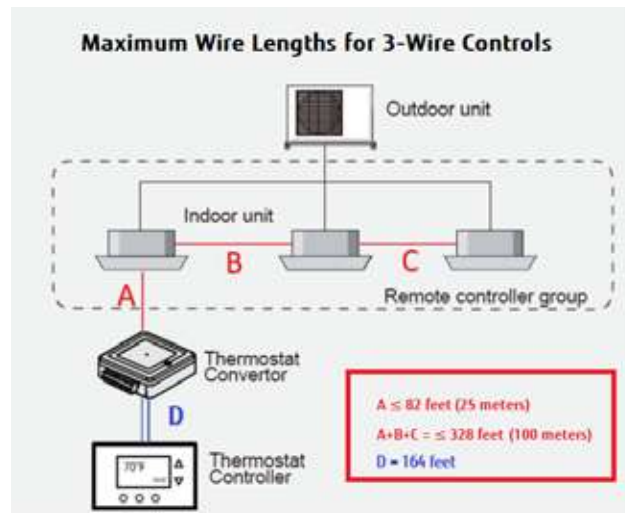
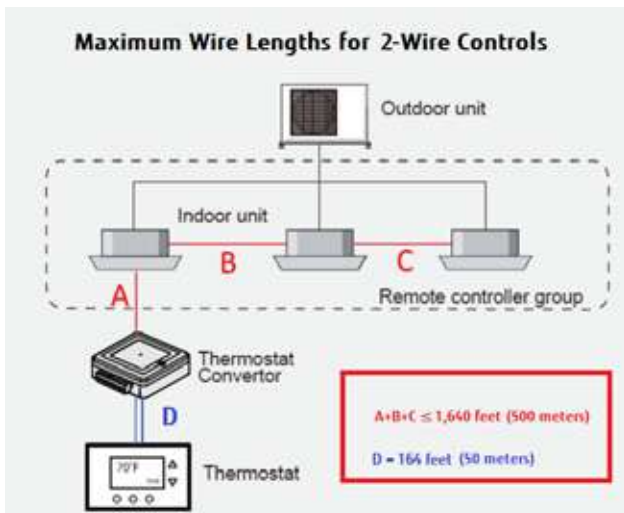

24V transformer (sold separately or included in TTRX-KIT)

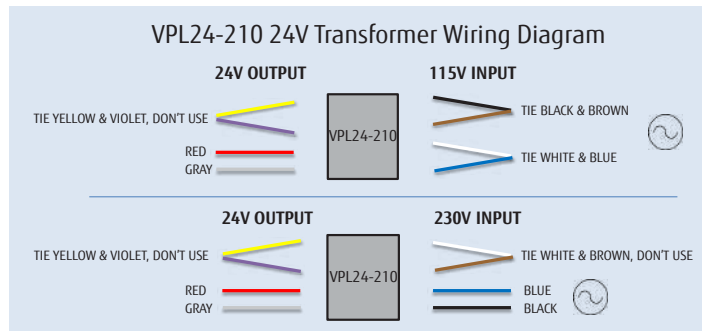

UTY-TTRX comes pre-set for 2-wire controls. For 3-wire systems, remember to change "Set 1" to 3-wire mode.

Specifications

Model Name	UTY-TTRX
Max. Connectable Indoor Units	16
Input Power Max.	0.6 W
Dimensions (HxDxW)	1-1/16 × 3-7/16 × 3-7/16 in. (27 × 86.7 × 86.7 mm)
Weight	7.8 in. (220 g)

Service Tool

UTY-ASGXZ1 Software

Monitor and control up to
400
indoor units

Monitor and control up to
100
outdoor units



Extensive monitoring and analysis functions installation, maintenance, and system status analysis

- Operation status can be checked and analyzed in detail
- Offer secure remote monitoring and control
- Storage of data on system operation status on a PC allows remote access.
- Up to 400 indoor units (a single VRF network system) can be controlled and monitored for large scale buildings or hotels
- This software can be connected to any point of transmission line with USB adapter

Automatic operation check

Time saving automatic self-diagnosis of system operation with detailed report of status and condition.



[Note] Use only as a guide and judge for yourself finally.

Whether each sensor value is normal is judged automatically.

- Discharge temperature normal value **OK**
 - Super heat volume normal value **OK**
 - High pressure pipe normal value **OK**
 - Low pressure pipe normal value **OK**
- ...etc.



Remote technical support & maintenance

Efficient tech support with online chat function, on-site check screen that can be shared remotely or in real time on site.

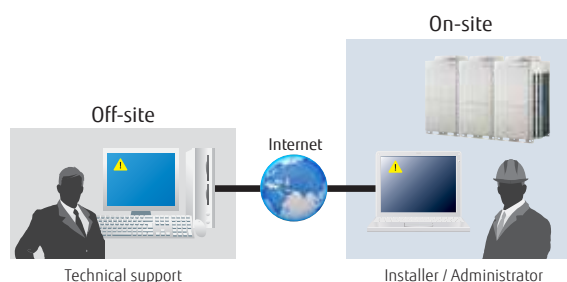

Multiple trend graph display and comparison

- Multiple graphs can be displayed in Service Tool as required
- Two offline data files can be viewed and compared simultaneously



Personal computer system requirements:

Model name	UTY-ASGXZ1	
Operating system	<ul style="list-style-type: none"> • Microsoft® Windows® 7 Professional (32-bit or 64-bit) SP1 • Microsoft® Windows® 8.1 Pro (32-bit or 64-bit) • Microsoft® Windows® 10 Pro (32-bit or 64-bit) 	
CPU	1 GHz or higher	
Memory	<ul style="list-style-type: none"> • 1 GB or more (for Windows Vista®, Windows® 7 [32-bit], Windows® 8.1 [32-bit], and Windows® 10 [32-bit]) • 2 GB or more (for Windows® 7 [64-bit], Windows® 8.1 [64-bit], and Windows® 10 [64-bit]) 	
HDD	40 GB or more of free space	
Display	1366 x 768 or higher resolution	
Interface	<ul style="list-style-type: none"> • 2 USB ports - 1 USB port is required for software protection key connection - 1 USB port is required for Echelon® U10 USB Network Interface 	
Software	Internet Explorer® 11 or Microsoft Edge / Adobe® Reader® 9.0 or later	

Packing List	Quantity	Application
WHITE-USB-KEY (Software protection key)	1	Software protection key to be connected to USB port on the Service Tool-installed PC. These products runs only on a PC with WibuKey.

- Personal computer that satisfies the following system requirements
- Echelon® U10 USB Network Interface – TP/FT-10 Channel (Model number: 75010R) (Required for each VRF Network.)

Service Tool UTY-ASGXZ1 (continued)

Functions

The screenshot shows a web-based interface for a VRF system. The browser title is 'VRF System - Microsoft Internet Explorer'. The page title is 'VRF Hotel'. There are navigation tabs for 'System List', 'Draw', 'History', 'Error History', 'Control', and 'Others'. Below the navigation is a toolbar with 'Adaptor: Adaptor1', 'All Units', 'Ref. Info', 'Print', and 'Option' buttons. A status bar at the top right shows 'Indoor ID-001' and 'Outdoor ID1-001'. The main content is a table with columns: Ref, Unit, R/C/O, Name, Model, Type, Capacity (RTT/HA), Sizer, Operator, Mode, Set Temp (C/F), Room Temp (C/F), R.E.T. In (C/F), R.E.T. Out (C/F), SPV (IP), Error, Signal, Operator, and P. The table contains data for various indoor and outdoor units, including heat pumps, heat recovery units, and cooling-only units. Some error status cells are highlighted in red.

Ref	Unit	R/C/O	Name	Model	Type	Capacity (RTT/HA)	Sizer	Operator	Mode	Set Temp (C/F)	Room Temp (C/F)	R.E.T. In (C/F)	R.E.T. Out (C/F)	SPV (IP)	Error	Signal	Operator	P
00	00				Heat Pump	-	-	ON	Idle	-	-	-	-	-	Normal	-	-	-
	00				Wall Mounted	7000	1B	ON	Cool	26	0	16	16	1600	Error	-	-	Ar
01	01		I/A Fin		Heat Recovery	-	1	ON	Idle	-	-	-	-	1600	Error	-	-	Low
	00	00	I/A In1		Wall Mounted	7000	I/A	ON	Cool	26	13.5	16	16	1600	Normal	-	-	Ar
	02	02	I/A In2		Wall Mounted	7000	I/A	ON	Cool	26	13.5	16	16	1600	Normal	-	-	Ar
	03	03	I/A In3		Wall Mounted	7000	I/A	ON	Cool	26	13.5	16	16	1600	Normal	-	-	Ar
02	02				Heat Pump	-	1A	ON	Idle	-	-	-	-	1600	Normal	-	-	Low
	02				Universal	7000	I/A	ON	Cool	26	13.5	16	16	1600	Normal	-	-	Ar
03	03		I/A Cooling-07		Cooling Only	-	1A	ON	Idle	-	-	-	-	1600	Normal	-	-	St
	03				Wall Mounted	7000	I/A	ON	Cool	26	13.5	16	16	1600	Normal	-	-	Ar
04	04		I/A Cooling22		Cooling Only	-	1A	ON	Idle	-	-	-	-	0	Normal	-	-	Low
	04				Wall Mounted	7000	I/A	ON	Cool	26	13.5	16	16	1600	Normal	-	-	Hi
05	05		1B Heat Pump M14		Heat Pump	-	-	ON	Idle	-	-	-	-	-	Normal	-	-	-
	05				Heat Pump	-	-	ON	Idle	-	-	-	-	-	Normal	-	-	-
	05				Universal	7000	1B	ON	Cool	26	13.5	16	16	1600	Normal	-	-	Hi

1) System List

Displays the overall operation status of all or specified units in the system in list form.

2) Equipment Detail (Diagram)

Displays detail information for sensor values, electrical components etc. for specified units in schematic. Information can be used to check operation status of units and make detail analysis.

3) Equipment Detail (List)

Displays the detail information for sensor values, electrical components etc. of units in a specified refrigerant system.

4) Operation History

Record of indoor units or outdoor unit operation. The displayed operation history can be printed or saved to a CSV file.

5) Error History

Displays the information for each unit. The information can sequentially be displayed up to 50 items.

6) Remote File Download

Operation history for specified system, units and times can be downloaded.

7) Commissioning Tool

During a test run, the outdoor unit/indoor unit sensor data can be saved for completing the commissioning report. When test concludes, this data can be exported in CSV file format.

8) Network Topology Analyzer

A list of units connected to the VRF system network is displayed in network segments in tree form.

9) Remote Setting

Setting of the indoor unit can be performed remotely.

10) System Time Setting

Time of day setting, for all controllers in a system, can be performed simultaneously.

11) Software Version

The software version of units is displayed.

12) Central Adjustment

Limitations on individual indoor units can be adjusted from the central controller (remote controller limit, temperature limit).

13) Model Name Writer

A custom model name can be given for an indoor unit.

14) Error Memory Reader

If an error occurs in an indoor unit, the system records the operation data before the error and saves to a CSV file.

Note: To perform "Error Memory Reading", the Service Tool must be connected directly to the corresponding outdoor unit. Refer to the Operation Manual of the Service Tool for detail.

15) Time Guard Information

Data for determining maintenance schedule (integrated time for compressor, fan, etc.) for the indoor and outdoor units can be output to a CSV file.

Web Monitoring Tool

UTY-AMGXZ1 Software

Can support up to
4
refrigerant circuits

Up to
1,600
indoor units supported

Product features

- Enables remote monitoring and troubleshooting
- Remote operation status notification via dedicated internet connection
- No special software needed to view data remotely, requires only general web browser.

Web Monitoring System

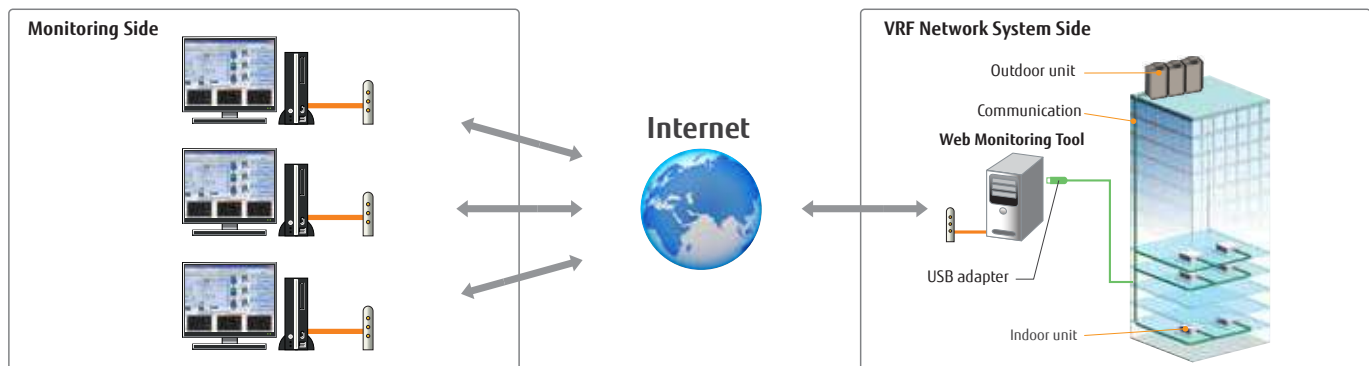

Support 4 VRF network systems

Monitoring of up to 1,600 indoor units via USB adapter.
Suitable for large-scale buildings or hotels.

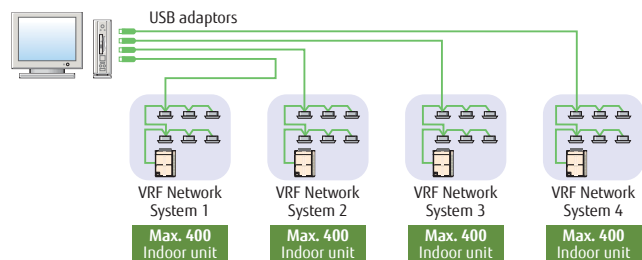

Personal computer system requirements:

Model name	UTY-AMGXZ1
Operating system	<ul style="list-style-type: none"> • Microsoft® Windows® 7 Professional (32-bit or 64-bit) SP1 • Microsoft® Windows® 8.1 Pro (32-bit or 64-bit) • Microsoft® Windows® 10 Pro (32-bit or 64-bit)
CPU	1 GHz or higher
Memory	<ul style="list-style-type: none"> • 1 GB or more (for Windows Vista®, Windows® 7 [32-bit], Windows® 8.1 [32-bit], and Windows® 10 [32-bit]) • 2 GB or more (for Windows® 7 [64-bit], Windows® 8.1 [64-bit], and Windows® 10 [64-bit])
HDD	40 GB or more of free space
Display	1366 x 768 or higher resolution
Interface	<ul style="list-style-type: none"> • USB port (for 10 USB Network Interface Max.4, Software protection key) • Either of the following interface is required for remote connection: <ul style="list-style-type: none"> - Internet using LAN: Ethernet port is required
Software	Internet Explorer® 11 or Microsoft Edge / Adobe® Reader® 9.0 or later

Packing list	Quantity	Application
WHITE-USB-KEY (Software protection key)	1	Software protection key to be connected to USB port on the Service Tool-installed PC. These products runs only on a PC with WibuKey.

- Personal computer that meet the following system requirements
- Echelon® U10 USB Network Interface – TP/FT-10 Channel (Model number: 75010R) (Required for each VRF Network.)

Design Simulator

Easy equipment selection, complete selection output, reliable project management

Fujitsu's Design Simulator makes it easy to design and select equipment for complex building HVAC systems. The software output contains all important design data including: Equipment Schedule, Piping and Wiring Layout, etc. (all of the information that typically is needed to estimate a VRF project) Design Simulator simplifies the design process. To design a system, just select the indoor unit types for each system, and the software will automatically select the outdoor unit and create the piping and wiring diagram. Design Simulator also checks all of the equipment information to ensure proper installation.



Step 1 Select the model

Choose the model for each system.



Step 2 Select the Indoor Unit

Choose the unit types and the conditions and the software will select the correct indoor unit. Indoor unit can also be selected manually.



Step 2b Select the Outdoor Air Unit

If desired, choose the "Outside Air Unit" option. Outside Air Units are selected based on required airflow.



Step 3 Select the Outdoor Unit

Using the Drag & Drop function, connect the indoor unit to the appropriate outdoor unit.

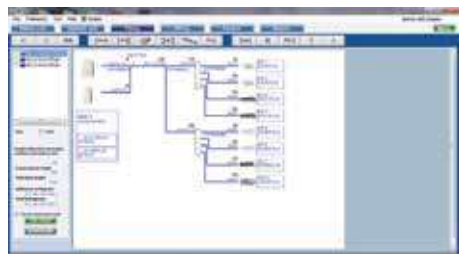

Step 4 Piping Length / Piping Diagram

Piping diagram is created automatically. As piping lengths are entered, system automatically calculates refrigerant charge.

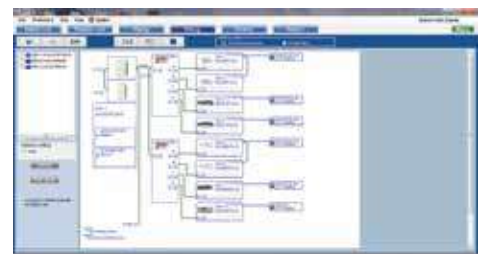

Step 5 Wiring / Remote Control Diagram

Automatically creates the wiring diagram. Simple grouping functions create a custom wiring diagram for the project.



Step 6 Select BMS Gateways and Central Controllers

Choose additional devices to meet the needs of the project.



Step 7 Report Output

Design Simulator creates a project output with all of the project schedules and schematic drawings.

Setting

Design Simulator can be customized for any geographic location.

- Units (US conventional / Metric)
- Language Setting
- Custom Database Function
- Output Settings

Design Simulator (continued)

Name of software	Design Simulator	
Latest Version	Design Simulator	Ver 3.6.4.01 (PG)
	DB	Ver 2021.07.27(DB)
	Design Simulator Installation	Ver1.0.5.01 (PG)
	DB	Ver 2021.07.27(DB)
	Design Simulator Drawing	Ver 0.1.4.01 (PG)
DB	Ver 2021.07.27(DB)	
Personal Computer	Compatible machine that runs Microsoft® 8.1/10	
Copyright holder	FUJITSU GENERAL LIMITED	
System requirements	Hardware	CPU: Intel® Core™ i3 2GHz or higher
		Memory: 2GB or more (Windows® 8.1/10 32-bit) 4GB or more (Windows® 8.1/10 64-bit)
		HDD: 10GB or more of free space
	Display	1024 x 768 or higher resolution
	Software	Internet Explorer® 11.0
Adobe® Reader® 10.0 or later		
Microsoft® Word 2010/2013/2016/2019 PDF Output Microsoft® Word, Excel 2010/2013/2016/2019 Microsoft® .NET Framework 4.6.1 or Higher		

Output

Equipment selections and schedules can be output in standard industry file formats.

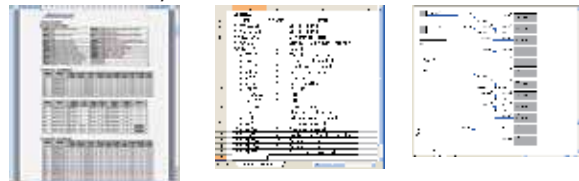

- Word format
- Excel format
- Auto CAD format
- 2D Data
- 3D Data (RevitMep data)
- Wiring and piping schematic drawings

Auto Update

Software updates automatically with the latest product data.

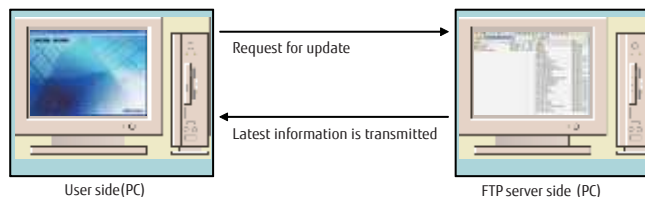

- Maintains software integrity
- Maintains software history
- Updates product information

Building Information Modeling (BIM)

Fujitsu provides the Building Information Modeling (BIM) object models and contents for our VRF system to the architect, designer and contractor using Autodesk® Revit® technology.

Required software:

Autodesk® Revit® series software:

- Autodesk® Revit® Architecture
- Autodesk® Revit® MEP
- Autodesk® Revit® Structure

Data format:

- RFA

Product parameter

Power source
Input power
Capacity
Airflow rate
Sound pressure level
Dimensions
Weight
Connection pipe diameter
Refrigerant
Material/Color

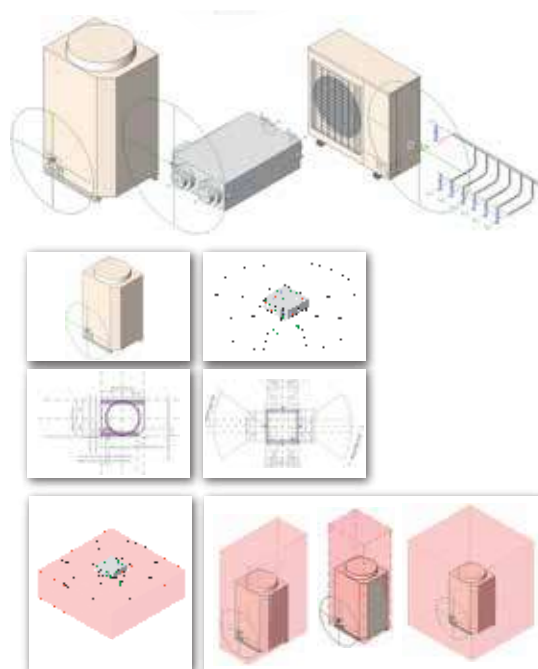

Cypetherm Fujitsu with EnergyPlus™

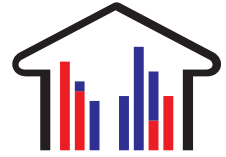

Intuitive Airstage Energy Modeling

This software allows you to model and simulate HVAC energy demand and consumption in the building with Airstage and compare with other commonly used HVAC equipment. Estimate potential energy savings and ROI values.

Easy Modeling

- Easy Wizard for Modeling
- 200 plus US cities included for weather data
- Default values selected based on building types

Simple Reports

- Simple Energy Demand/Consumption reports
- Comparison with existing/alternative HVAC system
- ROI, NCV number

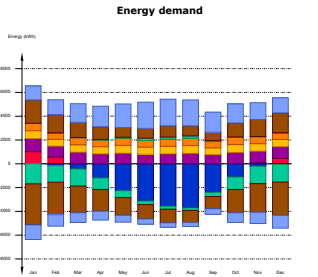
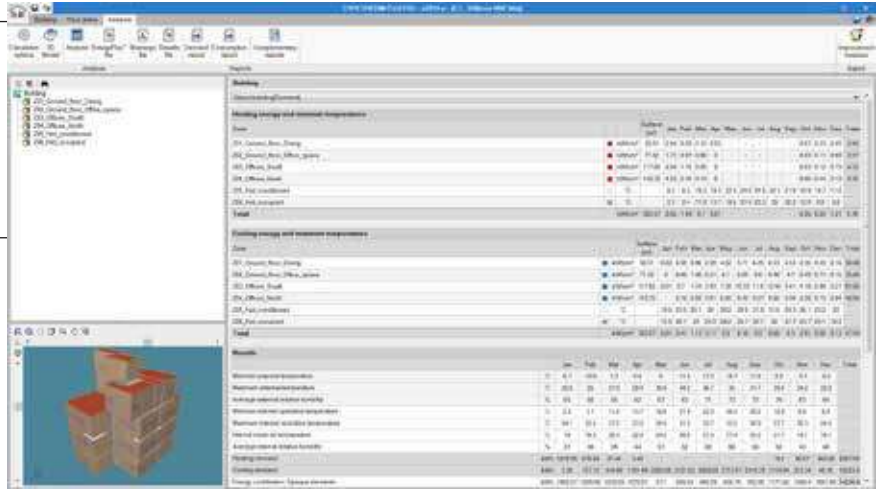

The following table displays the numerical values of the preceding bar chart, the energy balance of the whole building, as the sum of the energy involved in the energy balance of each thermal zone of the building calculation model.

The sign criteria adopted consists of using positive values for energy contributed to the zone and negative values for energy that is extracted.

Month	Jan	Feb	Mar	Apr	May	Jun	Jul	Aug	Sep	Oct	Nov	Dec	Year
Building	1066.4	1024.8	1212.1	1022.5	872.0	628.5	468.4	702.1	1073.0	1004.4	1468.1	1603.8	-28.51
Q1	1066.4	1024.8	1212.1	1022.5	872.0	628.5	468.4	702.1	1073.0	1004.4	1468.1	1603.8	-28.51
Q2	1066.4	1024.8	1212.1	1022.5	872.0	628.5	468.4	702.1	1073.0	1004.4	1468.1	1603.8	-28.51
Q3	1066.4	1024.8	1212.1	1022.5	872.0	628.5	468.4	702.1	1073.0	1004.4	1468.1	1603.8	-28.51
Q4	1066.4	1024.8	1212.1	1022.5	872.0	628.5	468.4	702.1	1073.0	1004.4	1468.1	1603.8	-28.51
Q5	1066.4	1024.8	1212.1	1022.5	872.0	628.5	468.4	702.1	1073.0	1004.4	1468.1	1603.8	-28.51
Q6	1066.4	1024.8	1212.1	1022.5	872.0	628.5	468.4	702.1	1073.0	1004.4	1468.1	1603.8	-28.51
Q7	1066.4	1024.8	1212.1	1022.5	872.0	628.5	468.4	702.1	1073.0	1004.4	1468.1	1603.8	-28.51
Q8	1066.4	1024.8	1212.1	1022.5	872.0	628.5	468.4	702.1	1073.0	1004.4	1468.1	1603.8	-28.51
Q9	1066.4	1024.8	1212.1	1022.5	872.0	628.5	468.4	702.1	1073.0	1004.4	1468.1	1603.8	-28.51
Q10	1066.4	1024.8	1212.1	1022.5	872.0	628.5	468.4	702.1	1073.0	1004.4	1468.1	1603.8	-28.51
Q11	1066.4	1024.8	1212.1	1022.5	872.0	628.5	468.4	702.1	1073.0	1004.4	1468.1	1603.8	-28.51
Q12	1066.4	1024.8	1212.1	1022.5	872.0	628.5	468.4	702.1	1073.0	1004.4	1468.1	1603.8	-28.51
Q13	1066.4	1024.8	1212.1	1022.5	872.0	628.5	468.4	702.1	1073.0	1004.4	1468.1	1603.8	-28.51
Q14	1066.4	1024.8	1212.1	1022.5	872.0	628.5	468.4	702.1	1073.0	1004.4	1468.1	1603.8	-28.51
Q15	1066.4	1024.8	1212.1	1022.5	872.0	628.5	468.4	702.1	1073.0	1004.4	1468.1	1603.8	-28.51
Q16	1066.4	1024.8	1212.1	1022.5	872.0	628.5	468.4	702.1	1073.0	1004.4	1468.1	1603.8	-28.51
Q17	1066.4	1024.8	1212.1	1022.5	872.0	628.5	468.4	702.1	1073.0	1004.4	1468.1	1603.8	-28.51
Q18	1066.4	1024.8	1212.1	1022.5	872.0	628.5	468.4	702.1	1073.0	1004.4	1468.1	1603.8	-28.51
Q19	1066.4	1024.8	1212.1	1022.5	872.0	628.5	468.4	702.1	1073.0	1004.4	1468.1	1603.8	-28.51
Q20	1066.4	1024.8	1212.1	1022.5	872.0	628.5	468.4	702.1	1073.0	1004.4	1468.1	1603.8	-28.51
Q21	1066.4	1024.8	1212.1	1022.5	872.0	628.5	468.4	702.1	1073.0	1004.4	1468.1	1603.8	-28.51
Q22	1066.4	1024.8	1212.1	1022.5	872.0	628.5	468.4	702.1	1073.0	1004.4	1468.1	1603.8	-28.51
Q23	1066.4	1024.8	1212.1	1022.5	872.0	628.5	468.4	702.1	1073.0	1004.4	1468.1	1603.8	-28.51
Q24	1066.4	1024.8	1212.1	1022.5	872.0	628.5	468.4	702.1	1073.0	1004.4	1468.1	1603.8	-28.51
Q25	1066.4	1024.8	1212.1	1022.5	872.0	628.5	468.4	702.1	1073.0	1004.4	1468.1	1603.8	-28.51
Q26	1066.4	1024.8	1212.1	1022.5	872.0	628.5	468.4	702.1	1073.0	1004.4	1468.1	1603.8	-28.51
Q27	1066.4	1024.8	1212.1	1022.5	872.0	628.5	468.4	702.1	1073.0	1004.4	1468.1	1603.8	-28.51
Q28	1066.4	1024.8	1212.1	1022.5	872.0	628.5	468.4	702.1	1073.0	1004.4	1468.1	1603.8	-28.51
Q29	1066.4	1024.8	1212.1	1022.5	872.0	628.5	468.4	702.1	1073.0	1004.4	1468.1	1603.8	-28.51
Q30	1066.4	1024.8	1212.1	1022.5	872.0	628.5	468.4	702.1	1073.0	1004.4	1468.1	1603.8	-28.51
Q31	1066.4	1024.8	1212.1	1022.5	872.0	628.5	468.4	702.1	1073.0	1004.4	1468.1	1603.8	-28.51
Q32	1066.4	1024.8	1212.1	1022.5	872.0	628.5	468.4	702.1	1073.0	1004.4	1468.1	1603.8	-28.51
Q33	1066.4	1024.8	1212.1	1022.5	872.0	628.5	468.4	702.1	1073.0	1004.4	1468.1	1603.8	-28.51
Q34	1066.4	1024.8	1212.1	1022.5	872.0	628.5	468.4	702.1	1073.0	1004.4	1468.1	1603.8	-28.51
Q35	1066.4	1024.8	1212.1	1022.5	872.0	628.5	468.4	702.1	1073.0	1004.4	1468.1	1603.8	-28.51
Q36	1066.4	1024.8	1212.1	1022.5	872.0	628.5	468.4	702.1	1073.0	1004.4	1468.1	1603.8	-28.51
Q37	1066.4	1024.8	1212.1	1022.5	872.0	628.5	468.4	702.1	1073.0	1004.4	1468.1	1603.8	-28.51
Q38	1066.4	1024.8	1212.1	1022.5	872.0	628.5	468.4	702.1	1073.0	1004.4	1468.1	1603.8	-28.51
Q39	1066.4	1024.8	1212.1	1022.5	872.0	628.5	468.4	702.1	1073.0	1004.4	1468.1	1603.8	-28.51
Q40	1066.4	1024.8	1212.1	1022.5	872.0	628.5	468.4	702.1	1073.0	1004.4	1468.1	1603.8	-28.51
Q41	1066.4	1024.8	1212.1	1022.5	872.0	628.5	468.4	702.1	1073.0	1004.4	1468.1	1603.8	-28.51
Q42	1066.4	1024.8	1212.1	1022.5	872.0	628.5	468.4	702.1	1073.0	1004.4	1468.1	1603.8	-28.51
Q43	1066.4	1024.8	1212.1	1022.5	872.0	628.5	468.4	702.1	1073.0	1004.4	1468.1	1603.8	-28.51
Q44	1066.4	1024.8	1212.1	1022.5	872.0	628.5	468.4	702.1	1073.0	1004.4	1468.1	1603.8	-28.51
Q45	1066.4	1024.8	1212.1	1022.5	872.0	628.5	468.4	702.1	1073.0	1004.4	1468.1	1603.8	-28.51
Q46	1066.4	1024.8	1212.1	1022.5	872.0	628.5	468.4	702.1	1073.0	1004.4	1468.1	1603.8	-28.51
Q47	1066.4	1024.8	1212.1	1022.5	872.0	628.5	468.4	702.1	1073.0	1004.4	1468.1	1603.8	-28.51
Q48	1066.4	1024.8	1212.1	1022.5	872.0	628.5	468.4	702.1	1073.0	1004.4	1468.1	1603.8	-28.51
Q49	1066.4	1024.8	1212.1	1022.5	872.0	628.5	468.4	702.1	1073.0	1004.4	1468.1	1603.8	-28.51
Q50	1066.4	1024.8	1212.1	1022.5	872.0	628.5	468.4	702.1	1073.0	1004.4	1468.1	1603.8	-28.51
Q51	1066.4	1024.8	1212.1	1022.5	872.0	628.5	468.4	702.1	1073.0	1004.4	1468.1	1603.8	-28.51
Q52	1066.4	1024.8	1212.1	1022.5	872.0	628.5	468.4	702.1	1073.0	1004.4	1468.1	1603.8	-28.51
Q53	1066.4	1024.8	1212.1	1022.5	872.0	628.5	468.4	702.1	1073.0	1004.4	1468.1	1603.8	-28.51
Q54	1066.4	1024.8	1212.1	1022.5	872.0	628.5	468.4	702.1	1073.0	1004.4	1468.1	1603.8	-28.51
Q55	1066.4	1024.8	1212.1	1022.5	872.0	628.5	468.4	702.1	1073.0	1004.4	1468.1	1603.8	-28.51
Q56	1066.4	1024.8	1212.1	1022.5	872.0	628.5	468.4	702.1	1073.0	1004.4	1468.1	1603.8	-28.51
Q57	1066.4	1024.8	1212.1	1022.5	872.0	628.5	468.4	702.1	1073.0	1004.4	1468.1	1603.8	-28.51
Q58	1066.4	1024.8	1212.1	1022.5	872.0	628.5	468.4	702.1	1073.0	1004.4	1468.1	1603.8	-28.51
Q59	1066.4	1024.8	1212.1	1022.5	872.0	628.5	468.4	702.1	1073.0	1004.4	1468.1	1603.8	-28.51
Q60	1066.4	1024.8	1212.1	1022.5	872.0	628.5	468.4	702.1	1073.0	1004.4	1468.1	1603.8	-28.51
Q61	1066.4	1024.8	1212.1	1022.5	872.0	628.5	468.4	702.1	1073.0	1004.4	1468.1	1603.8	-28.51
Q62	1066.4	1024.8	1212.1	1022.5	872.0	628.5	468.4	702.1	1073.0	1004.4	1468.1	1603.8	-28.51
Q63	1066.4	1024.8	1212.1	1022.5	872.0	628.5	468.4	702.1	1073.0	1004.4	1468.1	1603.8	-28.51
Q64	1066.4	1024.8	1212.1	1022.5	872.0	628.5	468.4	702.1	1073.0	1004.4	1468.1	1603.8	-28.51
Q65	1066.4	1024.8	1212.1	1022.5	872.0	628.5	468.4	702.1	1073.0	1004.4	1468.1	1603.8	-28.51
Q66	1066.4	1024.8	1212.1	1022.5	872.0	628.5	468.4	702.1	1073.0	1004.4	1468.1	1603.8	-28.51
Q67	1066.4	1024.8	1212.1	1022.5	872.0	628.5	468.4	702.1	1073.0	1004.4	1468.1	1603.8	-28.51
Q68	1066.4	1024.8	1212.1	1022.5	872.0	628.5	468.4	702.1	1073.0	1004.4	1468.1	1603.8	-

CPQ from Oracle - Configure, Price & Quote

(Airstage Project Manager (APM) replacement)

Oracle CPQ Cloud provides a cloud based Configure, Price and Quote system that offers extreme ease of use and configurability, creating, and managing quotes. Convert quotes into orders within the same platform.



Features

- Configure product easily through product pages or import from csv
- Create quote combining multiple products families
- Manage changes in quotes through version control
- Request discount either by line level or quote level
- Notification of approvals and easily track quotes
- User access control and management
- Convert quotes to order through click of a button



Optional Parts Overview

Optional Parts

For Cassette



Human Sensor Kit
Room temperature can be controlled by detecting the temperature accurately from the built-in sensor



Cassette Grille
Flexibility to match various interiors with extensive cassette grille lineup.



Outside Air Intake Kit
Outside air can be brought in via the indoor unit by external fan connected to the kit.

UTZ-KXGA for Cassette AUUB30,36
UTZ-KXGB for Cassette AUUB18,24
UTZ-KXGC for Compact Cassette AUUA7 thru AUUA24

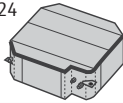

Insulation for High Humidity
Optional Insulation kit can be used to avoid condensation in high humidity installation locations.

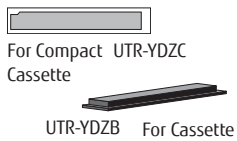

Air Outlet Shutter Plate
If required, a shutter plate can be field installed to make the cassette into a 3-way cassette.

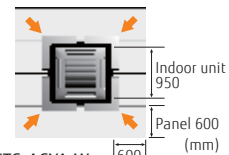

Wide Panel
Optional Wide Panel can be used to fill space around cassette.

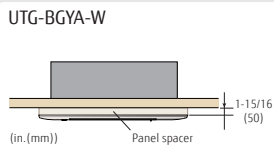

Panel Spacer
If required, Panel Spacer can be used to fill vertical space between ceiling and the cassette.

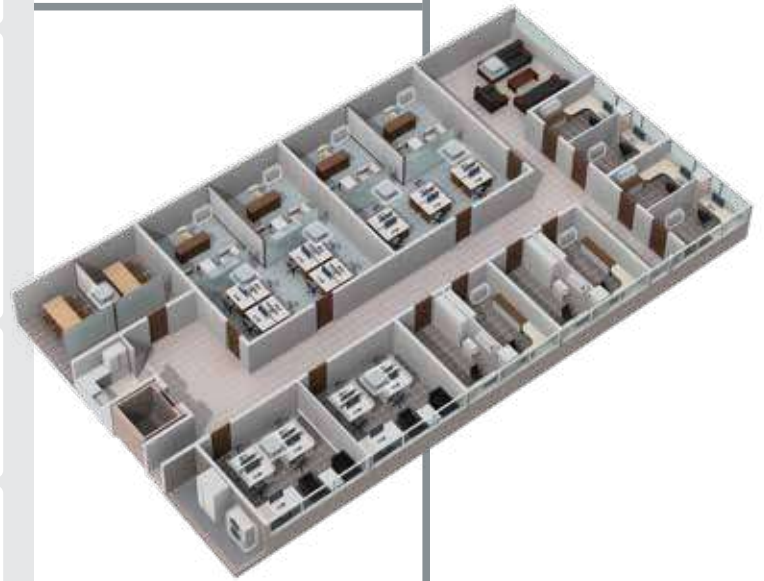

Optional Parts

For Floor

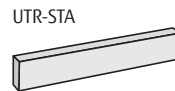

Half Concealed Kit
Kit can be used to partly cover floor type indoor units when mounted by a wall.

Optional Controls

For Ducted Indoor Units



Airzone
Communicating zoning system featuring proportional, modulating dampers and smart controllers.

Optional Controls

For Indoor Units



Highrise 360 Kit
Kit increases the max height difference between outdoor and indoor unit.



Optional Parts

For Duct & Ceiling



UTD-GXSA-W / UTD-GXTA-W
UTD-GXTB-W

Auto Louver Grille Kit
Elegant Grille kit for comfortable air distribution.



UTY-XSZX

Remote Sensor Unit
Remote sensor for localized temperature sensing and increased comfort.



UTD-LF25NA
UTD-LF60KA

Long Life Filter
Efficient Long Life air filter for reduced service requirements.

UTD-SF045T



UTD-RF204

Flange
Adapter Flange for connection of air ducts.

UTZ-PX1NBA
UTR-DPB24T



Condensate Drain Pump

Connection Parts

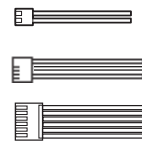

External Connect Kit & Set
Wire Connection kit for connection of external devices to Indoor unit.



Pipe Connection Units
For branch connections in VRF systems with multiple indoor units.



External Power Supply Unit
Can protect the units in the system even if some powers of indoor units are shut down in the system.

Optional Parts

For Outdoor Unit



Wind Baffles
Prevent fan stoppage against high wind



Snow Hood
Prevent snow accumulation inside outdoor unit



Hail Guard
Protection of outdoor unit coil from hail

REQUIRED for all Airstage system installations

VRF Communication Cable

LonWorks® Cable
K00250LW
K00500LW



Piping Accessories

Separation Tubes

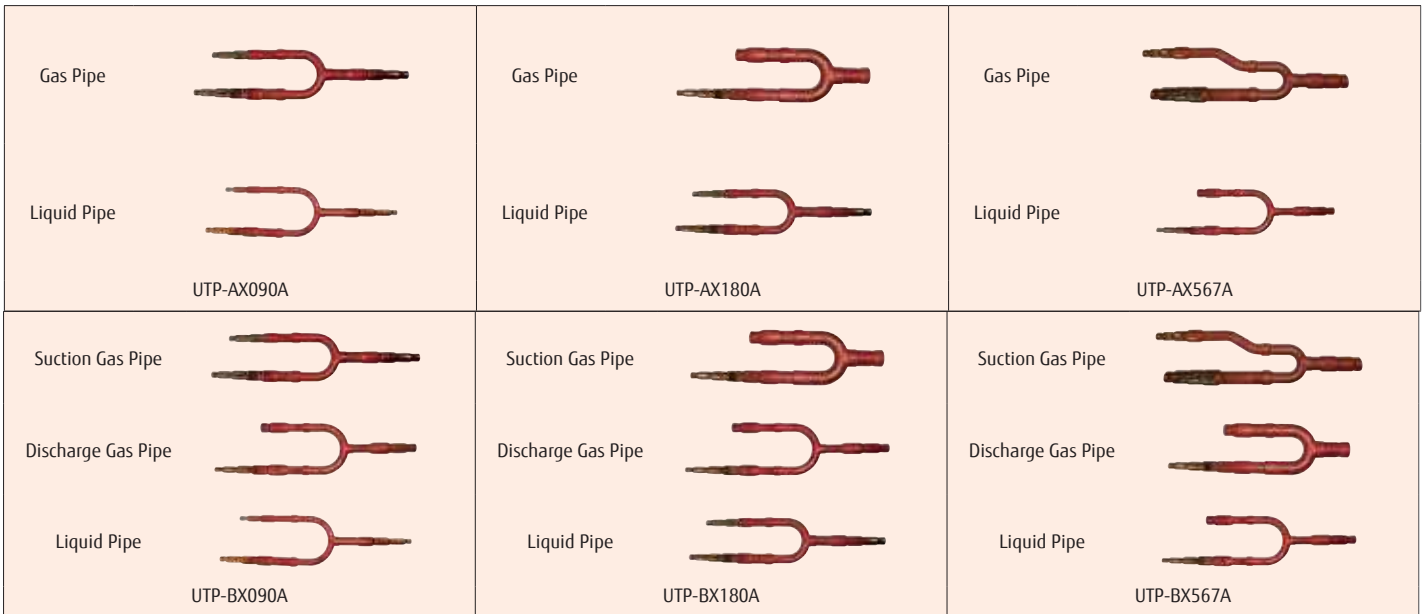

Specifications

Separation Tube

Model name	UTP-AX054A	UTP-AX090A	UTP-AX180A	UTP-AX567A
Total cooling capacity of indoor unit (X) (kBTUh)	X < 66.0	X < 96.5	96.5 ≤ X < 193	193 ≤ X

Model name	—	UTP-BX090A	UTP-BX180A	UTP-BX567A
Total cooling capacity of indoor unit (X) (kBTUh)	—	X < 96.5	96.5 ≤ X < 193	193 ≤ X

Outdoor Unit Branch Kit

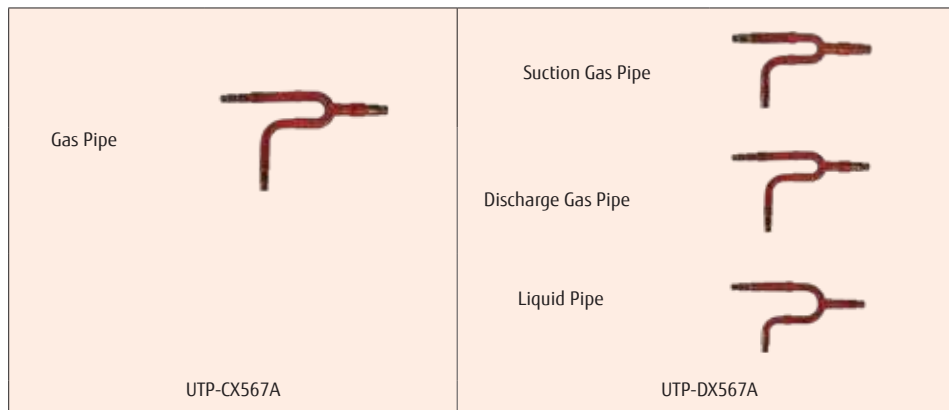

Specifications

Outdoor Unit Branch kit

Model name	UTP-CX567A (for V-II)	UTP-DX567A (for VR-II)
Number of Outdoor unit	2 outdoor units	1
	3 outdoor units	2

Header

8 Branch		6 Branch	
Gas Pipe		Gas Pipe	
Liquid Pipe		Liquid Pipe	
UTR-H0908L / UTR-H1808L		UTR-H0906L / UTR-H1806L	
Suction Gas Pipe		Suction Gas Pipe	
Discharge Gas Pipe		Discharge Gas Pipe	
Liquid Pipe		Liquid Pipe	
UTP-J0908A / UTP-J1808A		UTP-BX090A	

Specifications Header

Model name	3-6 Branches	UTR-H0906L	UTR-H1806L
	3-8 Branches	UTR-H0908L	UTR-H1808L
Total cooling capacity of indoor unit (X) (kBTUh)		X < 96.5	96.5 ≤ X < 193
Model name	3-6 Branches	UTP-J0906A	UTP-J1806A
	3-8 Branches	UTP-J0908A	UTP-J1808A
Total cooling capacity of indoor unit (X) (kBTUh)		X < 96.5	96.5 ≤ X < 193

RB Unit

Single type	Multi type		
UTP-RX01AH / UTP-RX01BH / UTP-RX01CH	UTP-RX04BH	UTP-RU08AH	UTP-RU12AH

Specifications RB Unit

Type	Single type			Multi type			
Model name	RU01AH	RU01BH	RU01CH	RU04BH	RU08AH	RU12AH	
Power source	Single phase 230V, 50Hz			Single phase 230V, 50Hz	Single phase 230V, 60Hz		
Input power	W	28	28	41	110	226	339
Number of branches	1	1	1	4	8	12	
Maximum capacity of connectable indoor units (Q)	kBTUh	Q ≤ 28	Q ≤ 60	Q ≤ 96	Q ≤ 191*1	Q ≤ 245,000	Q ≤ 324,000
Maximum capacity of connectable indoor units per branch (Q)	kBTUh	Q ≤ 27	Q ≤ 60	Q ≤ 96	Q ≤ 96	Q ≤ 27,000	Q ≤ 27,000
Max number of connectable indoor units per branch		3	8	8	8	6	6
Dimensions (H×W×D)	in. (mm)	7-13/16 × 11-3/4 × 10-9/16 (198 × 298 × 268)			10-1/4 × 25-7/8 × 16-7/8 (260 × 658 × 428)	11-3/4 × 26 × 24-5/16 (298 × 660 × 618)	11-3/4 × 39 × 24-5/16 (298 × 990 × 618)

*1: In case of two RB units connected in series (total 8-branches), maximum capacity of connectable indoor units is up to 191kBTUh

Auto Louver Grille Kit (Option)

Models

UTD-GXSA-W / UTD-GXTA-W

UTD-GXSB-W

Available for Mini and Slim Ducted Indoor Units
(page 52)



Flexible Control

- Convenient control of Auto Louver kit from remote controller of indoor unit.
- Can be used for vertical auto swing or fixed louvers. 4 convenient louver angle settings.
- Louvers close automatically when indoor unit is not in operation.

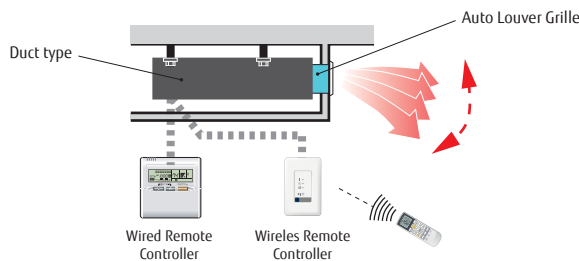

Dimensions

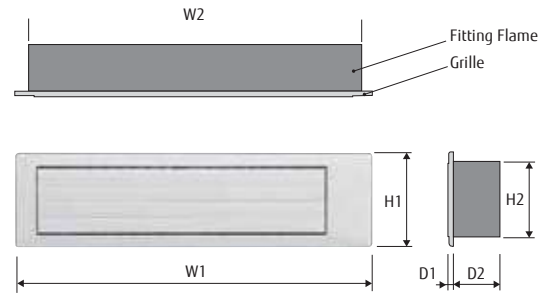

Model Name	W1	W2	H1	H2	D1	D2
UTD-GXSA-W / UTD-GXTA-W	26-7/8	25-3/8	7-1/16	5-13/16	3/8	3-5/16
UTD-GXSB-W	34-3/4	33-1/4				

Unit: In.

Specifications

Model name	UTD-GXSA-W / UTD-GXTA-W		UTD-GXSB-W
Applicable Indoor Unit	UTD-GXSA-W: ARUL7/9/12/14TLAV UTD-GXTA-W: ARUL4TLAV1		ARUL18TLAV
Power Supply	Connecting with Control box of indoor unit		
Fixing of Auto Louver Grille	Screw fixing to Flange or Square Duct		
Extension Square Duct Limit	39-3/8" (Max. duct length between indoor unit and grille)		
Net Dimension (H x W x D)	inch (mm)	7-1/16x26-7/8x(3-5/16+3/8) [180x683x(84+9)]	7-1/16x34-3/4x(3-5/16+3/8) [180x883x(84+9)]
Weight	Net	4.4 (2.0)	5.6 (2.5)
	Gross	6.7 (3.0)	7.8 (3.5)
Color	White		
Louver Motor	Stepping Motor		
Accessories	Fitting Flame, etc.		
Operation range	Cooling	°F (°C)	64 to 90 (18 to 32)
	Heating	% RH	80% or less
		°F (°C)	50 to 86 (10 to 30)

Wind Baffles

UTZ-DUWBUA

UTZ-DUWBTA

UTZ-DUWBRA

Protect Your Investment

Wind Baffles ensure continued operation during high wind conditions, especially with roof-mounted units. Wind Baffles prevent nuisance stoppage of outdoor unit.

Features

- Solid & sturdy design for durability and reduced vibrations
- Same color as outdoor air unit for better aesthetics
- Easy installation



Actual product color may be different from the colors shown here. Specifications and design are subject to change without notice.

AIRSTAGE MODEL	WIND BAFFLE MODEL	AIRSTAGE MODEL	WIND BAFFLE MODEL
AOU72RLAVL	UTZ-DUWBRA*	AOU36RLAVM	UTZ-DUWBTA*
AOU96RLAVL		AOU48RLAVM	
AOU120RLAVL		AOU60RLAVM	
AOU36RLAVS	UTZ-DUWBUA	AOU36RLAVM4	
AOU48RLAVS		AOU48RLAVM4	
AOU36RLAVS4		AOU60RLAVM4	
AOU48RLAVS4			

NOTE: Wind baffles do not extend low ambient cooling capacities. Please refer to Application Bulletin AH20201101A for best practices regarding wind baffle usage.

COMING SOON! Hail Guards, Snow Hoods

SNOW HOODS						
AIRSTAGE MODEL	GROUP	UTZ-DUSHUA	UTZ-DUSHTA	UTZ-DUSHRA	UTZ-DUSHVTA	UTZ-DUSHVUA
AOU36RLAVS	U	1				
AOU48RLAVS		1				
AOU36RLAVM	T		1			
AOU48RLAVM			1			
AOU60RLAVM			1			
AOU72RLAVL	R			1		
AOU96RLAVL				1		
AOU120RLAVL				1		
AOUA72RLBV1	VT				1	
AOUA96RLBV1					1	
AOUA120RLBV1	VU					1

Snow Hoods - Protect your outdoor equipment from poor performance due to accumulation of snow.



Hail Guard - Project your outdoor unit coil from hail damage.

HAIL GUARDS						
AIRSTAGE MODEL	GROUP	UTZ-DUHGUA	UTZ-DUHGTA	UTZ-DUHGRA	UTZ-DUHGVTA	UTZ-DUHGVUA
AOU36RLAVS	U	1				
AOU48RLAVS		1				
AOU36RLAVM	T		1			
AOU48RLAVM			1			
AOU60RLAVM			1			
AOU72RLAVL	R			1		
AOU96RLAVL				1		
AOU120RLAVL				1		
AOUA72RLBV1	VT				1	
AOUA96RLBV1					1	
AOUA120RLBV1	VU					1

Airzone

Compatible with most Airstage 2-wire and 3-wire single zone systems.

Airzone is an intelligent, communicating zoning system Airstage ducted indoor units, featuring proportional, modulating dampers and smart controllers. Additional ductless and ducted single zone systems may be integrated for total HVAC control.

How does it work?

All Airzone dampers and optional Zone Modules are connected by a 4-wire cable, for power and communication. Dampers are positioned to provide optimum airflow into a zone based upon demand monitored through zone controllers. The indoor unit fan is adjusted to meet the instantaneous sum of all calling zones.



Commercial Application- Wide range of damper sizes both wired and wireless allows implementing into lite commercial projects easier.



Airzone VAF Wired Principal Controller White



Airzone VAF Control Board with Fujitsu UART Communication Region 2



Airzone VAF 8" Wired Intelligent Round Damper



Airzone VAF 8" Wireless Intelligent Round Damper

Benefits

- An Airzone system can provide optimum airflow into each zone, thus reducing excess equipment capacity.
- Provides ideal temperature control of each zone in your home or office.
- Built in communication gateways maximize Fujitsu Heat Pump inverter efficiency.
- Integrate single zone systems with the ducted, modulating damper system.
- Modulating dampers and proportional fan control eliminates the need for a bypass duct!
- Flexibility of selection damper size and controllers individually for wide range of application.

Features

- Control and monitor up to 10 individual zones.
- Adjustable minimum and maximum damper positions.
- Control of optional auxiliary heat of the ducted, zoned unit.
- Principal controller provides simple, single point temperature management of ALL zones!
- Wired and wireless dampers available. Size ranges from 6" to 14" in diameter.
- Flexible control of up to 10 hydronic zones is possible, as either primary or auxiliary heat.
- Dry Contact Inputs from occupancy sensor and windows operation to open/close individual damper.

Connection Diagram

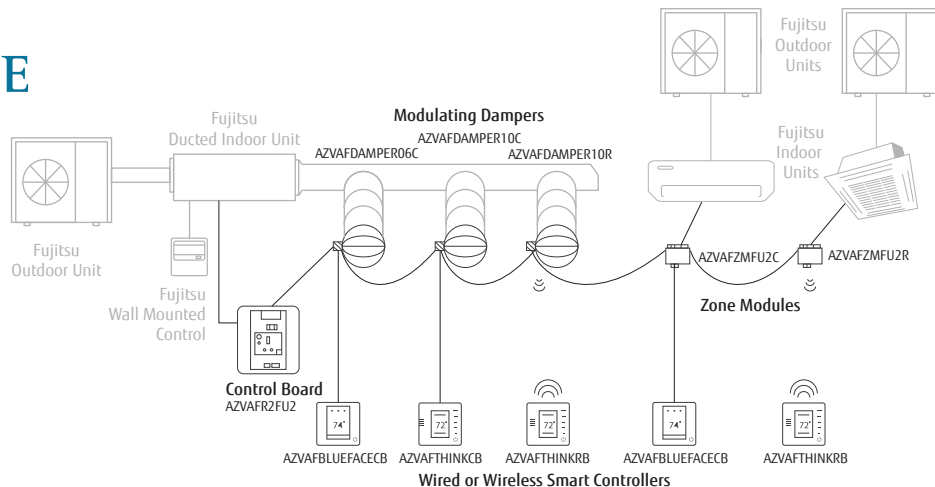

Airzone, cont'd.



PRODUCT OFFERING		
FAMILY	REFERENCE VAF	DESCRIPTION
Control board	AZVAFCB2FUJ	AIRZONE VAF CONTROL BOARD WITH FUJITSU 3 WIRES COMMUNICATION REGION 2
	AZVAFCB2FU2	AIRZONE VAF CONTROL BOARD WITH FUJITSU UART COMMUNICATION REGION 2
Controllers	AZVAFBLUEFACECB	AIRZONE VAF WIRED BLUEFACE PRINCIPAL CONTROLLER WHITE
	AZVAFTHINKCB	AIRZONE VAF WIRED THINK CONTROLLER WHITE
	AZVAFTHINKRB	AIRZONE VAF WIRELESS THINK CONTROLLER WHITE
	AZVAFLITECB	AIRZONE VAF WIRED LITE CONTROLLER WHITE
	AZVAFLITERB	AIRZONE VAF WIRELESS LITE CONTROLLER WHITE
Zone modules	AZVAFZMOFUJC	AIRZONE VAF WIRED ZONE MODULE WITH FUJITSU 3 WIRES COMMUNICATION
	AZVAFZMOFU2C	AIRZONE VAF WIRED ZONE MODULE WITH FUJITSU UART COMMUNICATION
	AZVAFZMOFUJR	AIRZONE VAF WIRELESS ZONE MODULE WITH FUJITSU 3 WIRES COMMUNICATION
	AZVAFZMOFU2R	AIRZONE VAF WIRELESS ZONE MODULE WITH FUJITSU UART COMMUNICATION
	AZVAFDAMPER06C	AIRZONE VAF 6" WIRED INTELLIGENT ROUND DAMPER
	AZVAFDAMPER08C	AIRZONE VAF 8" WIRED INTELLIGENT ROUND DAMPER
	AZVAFDAMPER10C	AIRZONE VAF 10" WIRED INTELLIGENT ROUND DAMPER
	AZVAFDAMPER12C	AIRZONE VAF 12" WIRED INTELLIGENT ROUND DAMPER
	AZVAFDAMPER14C	AIRZONE VAF 14" WIRED INTELLIGENT ROUND DAMPER
	AZVAFDAMPER06R	AIRZONE VAF 6" WIRELESS INTELLIGENT ROUND DAMPER
	AZVAFDAMPER08R	AIRZONE VAF 8" WIRELESS INTELLIGENT ROUND DAMPER
	AZVAFDAMPER10R	AIRZONE VAF 10" WIRELESS INTELLIGENT ROUND DAMPER
	AZVAFDAMPER12R	AIRZONE VAF 12" WIRELESS INTELLIGENT ROUND DAMPER
	AZVAFDAMPER14R	AIRZONE VAF 14" WIRELESS INTELLIGENT ROUND DAMPER
	AZVAFZMRADC	AIRZONE VAF WIRED ZONE MODULE ONLY RADIANT
AZVAFZMRADR	AIRZONE VAF WIRELESS ZONE MODULE ONLY RADIANT	
Zone-supplemental heating	AZVAF5OUTPUTS	AIRZONE VAF RELAY RADIANT HEAT CONTROL MODULE
Accessories	AZVAF10KPROBE	AIRZONE VAF 10 KOHM NTC THERMISTOR
	AZVAFPOWER	AIRZONE VAF ADDITIONAL 12V POWER SUPPLY
Spare parts	AZVAFDAMPERZMC	AIRZONE VAF SPARE DAMPER WIRED ZONE MODULE
	AZVAFDAMPERZMR	AIRZONE VAF SPARE DAMPER WIRELESS ZONE MODULE
	AZVAFDAMPERACT	AIRZONE VAF SPARE DAMPER ACTUATOR

Highrise 360 Kit (for V-II Series*)

UTY-SPWX

Design flexibility

The Highrise 360 kit increases the 164ft max height difference between outdoor unit and indoor unit to 360ft, when outdoor unit is located above the indoor units.

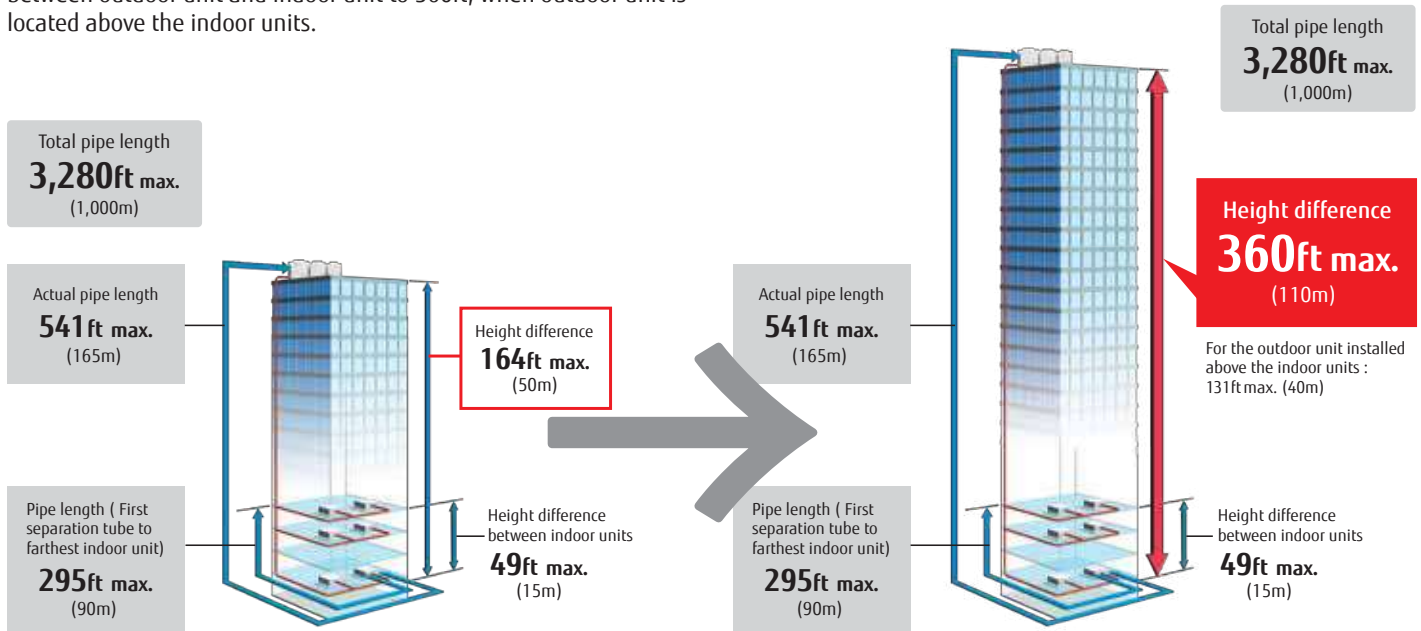

System Overview

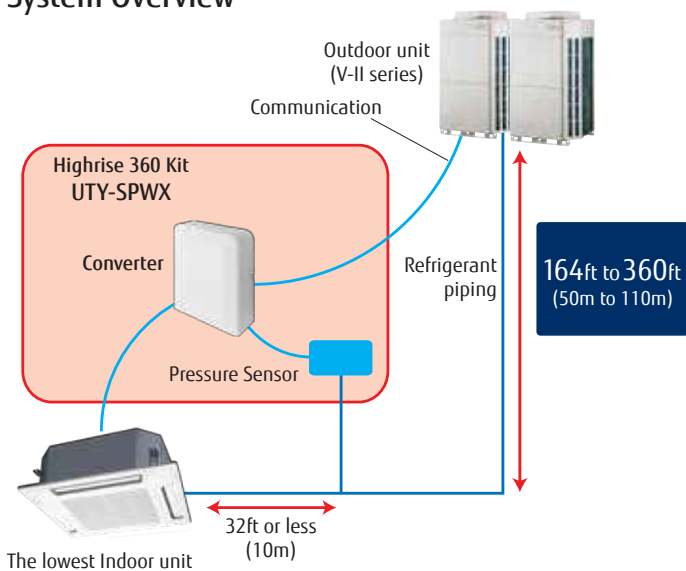

Highrise 360 Kit Components

Pressure sensor kit (Converter)	
Refrigerant pressure sensor	
Joint pipe	

* NOTE: This product can be used on newer V-II series only. For outdoor units with manufacturing dates before January 2018, a software upgrade can be requested. Please contact Fujitsu technical support for details.

Applications

There are many applications for Airstage VRF systems including such markets as education, healthcare, hospitality, utilities, office buildings, apartment buildings, condominiums, and restaurants.

Note: VRF Heat Recovery system provides simultaneous Heating and Cooling.

Medical and Healthcare Facilities

VRF gives each patient individual control of their room temperature. Central control ensures that air conditioning is only delivered to rooms that are occupied.

Individual Control

VRF systems give each patient or each room individual control of their room temperature.

Maintenance

Since each refrigerant circuit has the ability to operate independently, a properly designed VRF system can add a layer of security to a HVAC system. If an individual unit needs to be serviced, the rest of the system can operate normally.



Central Control

Powerful central control ensures that heating and cooling are delivered to rooms that are occupied. This provides enormous savings for facilities with changing occupancy.

Clean Air

VRF systems can use ductless indoor units reducing the time and expense of maintain a ducted HVAC system and minimizing the risk of spreading duct-borne molds and bacteria.

Healthier Facility

VRF systems can be integrated with outside air systems to ensure that air quality meets the needs of the occupants. VRF provides the most comfortable environment for all occupants.

Optional

Building Management System (BMS) using BACnet, LonWorks or Modbus.



See Airstage VRF case studies on our site at www.fujitsugeneral.com/us/commercial/benefits/app-and-solutions.html

or on our **YouTube** channel FujitsuGeneral_USA

Vertical Farming or Grow Houses - Controlled Environmental Agriculture (CEA)

Recently VRF has been applied to CEA to effectively control the indoor environment for vertical farming.

Fujitsu Airstage VRF Systems eliminate short cycling and ensure consistent temperature control for optimal grow operations.



Central Control

VRF Central Controls keep HVAC Technicians out of the Production Rooms, enhancing biosecurity.

With Internet access, systems can be monitored and controlled remotely. System performance is assessed in real time, offering retro-commissioning opportunities that keep them operating at peak performance.



Healthier Facility

Indoor Unit Fan Coils can be located in Production Rooms, avoiding contamination risk associated with packaged equipment located outdoors.



Efficient

Variable speed inverter-driven compressors adjust performance to match the different stages of plant growth, eliminating short cycling that leads to premature equipment failure and undesirable spikes in temperature and humidity.



Flexible

Systems are modular, allowing for a wide range of capacities.

See Airstage VRF case studies on our site at www.fujitsugeneral.com/us/commercial/benefits/app-and-solutions.html

or on our **YouTube** channel [FujitsuGeneral_USA](https://www.youtube.com/channel/UCFujitsuGeneral_USA)

Educational and Religious Facilities

In a school, an investment in VRF is an investment in your community. VRF is more efficient than conventional systems, providing financial savings to the school for many years. Also, a quiet VRF system creates a much better learning environment for students.

Healthier Facility

VRF systems can be integrated with outside air systems to ensure that air quality meets the needs of the teachers and students.

Central Control

Powerful central control can monitor and control individual schools, or an entire college campus, from a single location.



Zoning

Save energy by heating and cooling only the classrooms that are occupied. Set temperature can be pre-programmed to meet the energy budget for the school district.

Comfort

VRF helps achieve a healthier, quieter, more comfortable and productive learning environment.

Optional

Building Management System (BMS) using BACnet, LonWorks or Modbus. Subtenant billing and Energy Charge apportionment.

See Airstage VRF case studies on our site at www.fujitsu-general.com/us/commercial/benefits/app-and-solutions.html

or on our channel FujitsuGeneral_USA

Office Buildings and Retail Spaces

VRF provides a comfortable work environment for all employees. Zoning ensures that energy is only used to cool/heat occupied offices. Quiet indoor units and precise temperature control creates the most comfortable and productive work environment.

Flexible

As tenants and office configurations change, VRF system configurations can also be modified to meet the needs of new tenants.

Zoning

Save energy by only heating and cooling occupied offices. No more hot/cold calls since each zone or tenant has individual control of the set temperature.



Ease Of Installation

Can be installed in occupied office spaces with minimal disruption to occupants. Can even be installed without disrupting the existing HVAC system.

Quiet

Indoor units and outdoor units are quiet which creates a pleasant and productive work environment.

Control

Powerful controls options can manage and monitor entire building from a single location.

Comfort

VRF provides a comfortable work environment for all employees. Quiet indoor units and precise temperature control creates the most comfortable and productive work environment.

Optional

Building Management System (BMS) using BACnet, LonWorks or Modbus. Subtenant billing and Energy Charge apportionment.

See Airstage VRF case studies on our site at www.fujitsugeneral.com/us/commercial/benefits/app-and-solutions.html

or on our **YouTube** channel FujitsuGeneral_USA

Multi-Tenant Dwellings

VRF improves the quality of multi-tenant buildings. High quality VRF systems enables owners to save on energy and maintenance costs. With VRF, each tenant has individual control over the temperature setting for the comfort of their home.

Quality

By delivering quiet, efficient, and individual heating and cooling VRF improves the quality and the environment of multitenant buildings.

Energy Savings

Efficient VRF systems reduce the total energy costs for buildings over most other options. High quality systems reduce maintenance and service costs.



Individual Billing

Using the Energy Charge Allocation feature, landlords can easily bill each tenant for the share of total energy the individual tenant consumes.

Individual Comfort

With VRF, each tenant can have their own controller to set their room temperature for their maximum comfort.

Convenient Central Control

Landlord can monitor and control all indoor units from a central location. Landlord can even troubleshoot remotely.

Quiet

Indoor units ensures a quiet, comfortable living environment for all tenants.

Optional

Subtenant billing and Energy Charge apportionment.



See Airstage VRF case studies on our site at www.fujitsugeneral.com/us/commercial/benefits/app-and-solutions.html or on our channel FujitsuGeneral_USA

Fujitsu Commercial Financing

For any commercial HVAC installation, you can turn to Fujitsu with confidence for equipment that's not only readily available, but also thoughtfully engineered to install with ease and save energy on utility bills.

The Fujitsu Commercial Financing program is just as efficient and smart:



Quick, efficient approval process

- No cost, recourse or credit check for contractors
- End user credit approvals in 2 – 6 hours
- Contractor paid within 24 – 48 hours of install
- Single point of contact, from beginning to end

Solutions available for most projects

- Commercial units eligible, as well as controls and installation
- Churches, nonprofits and non-building owners qualify

Take advantage of convenient quote options:

-  FujitsuGeneralFinancing.com
-  1-800-606-0049

For More Information:

Marlin Capital Solutions
800-606-0049



For residential installations, please inquire with your Distributor or Fujitsu Sales Engineer about consumer financing options.



Things to know before you buy a FUJITSU system

Complete System Warranty

Standard warranties vary depending on model:



All Fujitsu Airstage systems come standard with a 2-Year Compressor/1-Year Parts warranty.



Fujitsu Commercial Airstage systems that have been properly commissioned have a warranty of 10-Year Parts/10-Year Compressor.



Residential J-Series Systems installed/Registered by an Elite Contractor have a 12-Year Parts/12-Year Compressor Warranty. For more details, see Airstage Warranty Statement.

For full details, see Airstage Warranty Statement.

Trademarks

The Fujitsu logo is a registered trademark of Fujitsu Limited. The Airstage logo and name is a trademark of Fujitsu General America, Inc. ENERGY STAR® is a registered trademark of the EPA and DOE. Copyright © 2017 Fujitsu General America, Inc.

Non-Internet Retail Policy

Internet sales are strictly prohibited and unauthorized. Any HVAC systems purchased on the Internet, from an online retailer or any similar e-tailing website, OR where the original factory serial numbers of the display have been removed, defaced, or replaced in any way WILL NOT BE COVERED BY WARRANTY.

Note: Condensing units come pre-charged from factory. Additional refrigerant may be required, be sure to check installation manual for more details.

Things To Know Before You Install a FUJITSU System

Warning

Always use a licensed installer or contractor to install this product. Do not try to install the product yourself. Improper installation can result in water or refrigerant leakage, electrical shock, fire or explosion. Use only parts and accessories supplied or specified by Fujitsu. Ask a licensed contractor to install parts and accessories. Use of unauthorized or improper installation of parts and accessories can result in injury or property damage. Read the installation manual carefully before using this product. The installation manual provides important safety instructions and warnings which should be followed closely. For any questions or concerns, please contact Fujitsu General America, Inc. Proper sizing and installation of equipment is critical to achieve optimal performance.

Heat Pump Disclaimer

In most climates a heat pump will handle all of your heating needs. However, this system sometimes requires some other additional source of heat to satisfy heating requirements in the coldest environments. All of Fujitsu's heat pumps use inverter

technology and as such offer a wider operating range and more heat capacity than a standard heat pump but will not provide adequate heating if improperly sized or operated outside of its operating range. Specifications vary by model; please consult your contractor before choosing a heat pump as your only source of heat. Systems will maintain temperature up to +/-4 degrees relative to set temperature. To increase energy efficiency on multi-type systems, you should turn off the evaporators when heating or cooling is not needed.

Disclaimer

Fujitsu's products are subject to continuous improvements. Fujitsu reserves the right to modify product design, specifications and information in this brochure without notice and without incurring any obligations.

Certifications

ISO

ISO14001 is the standard defined by the International Organization for Standardization (ISO) related to environmental management systems. Fujitsu General America, Inc. has been acknowledged by an internationally accredited compliance organization as having an appropriate program of environmental protection procedures and activities to meet the requirements of ISO14001. The air conditioners manufactured by Fujitsu have received ISO9001 series certification for quality assurance.



- ISO9001
- ISO14001

ASTM

Our outdoor units shall withstand 1,000 hours of salt spray tested per procedure ASTM B117.

RoHS Compliant

Fujitsu participates in the RoHS Directive, which is the Restriction of Hazardous Substances in electrical and electronic equipment. It is an EU directive intended to protect the environment by forcing manufacturers to eliminate or severely curtail the use of cadmium, hexavalent chromium, and lead in all products from automobiles to consumer electronics.



AHRI Energy Guide® Program (U.S.)

To view AHRI numbers or Energy Guide labels, please go to www.ahridirectory.org.



HRAI EnerGuide® Program (Canada)

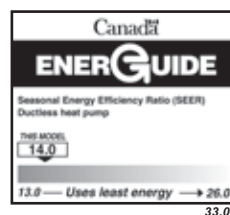

- Specifications and design are subject to change without notice for future improvement. For further details, please check with an authorized distributor.
- "AIRSTAGE" is a worldwide trademark of FUJITSU GENERAL LIMITED and is a registered trademark in Japan and other countries or areas.
- Other company and product names mentioned herein may be registered trademarks, trademarks or trade names of their respective owners.
- Actual product color may be different from the colors shown in this printed material.
- Internet sales are strictly prohibited and unauthorized. Any HVAC systems purchased on the Internet, from an online retailer or any similar e-tailing website, OR where the original factory serial numbers of the display have been removed, defaced, or replaced in any way WILL NOT BE COVERED BY WARRANTY.



- Specifications and design are subject to change without notice for future improvement.
- For further details, please check with our authorised dealer.
- The products or equipments in this catalogue contain fluorinated greenhouse gases.
- **AIRSTAGE**® is a worldwide trademark of FUJITSU GENERAL LIMITED and is a registered trademark in Japan and other countries or areas.
- **YGLair**® is a worldwide trademark of FUJITSU GENERAL LIMITED.
- iPhone and iPad are trademarks of Apple Inc., registered in the U.S. and other countries.
- **BACnet**® is a trademark or registered trademark of the American Society of Heating, Refrigerating and Air-Conditioning Engineers, Inc.
- **MODBUS**® is a registered trademark of Schneider Electric.
- **LONWORKS**® and Echelon are trademarks of Echelon Corporation registered in the United states and other countries.
- Other company and product names mentioned herein may be registered trademarks, trademarks or trade names of their respective owners.

Distributed by :

Part #7-26-FG6010 Rev. 10/2021
Copyright© 2021 Fujitsu General America, Inc. All rights reserved.

FUJITSU GENERAL AMERICA, INC.

340 Changebridge Road • Pine Brook, NJ 07058

Toll Free: (888) 888-3424

Local: (973) 575-0380

hvac@fujitsugeneral.com

www.fujitsugeneral.com

A subsidiary of

FUJITSU GENERAL LIMITED

